

**WALL CAP DETAILS** **PAGE #**

CLASSIC WALL CAP - GENERAL DETAILS	3
CLASSIC WALL CAP - SIZES	4
CLASSIC WALL CAP - GENERAL RADIUSSES	5
CLASSIC WALL CAP WITH RADIUS 10-1/4"WIDTH	6
CLASSIC WALL CAP WITH RADIUS 12"WIDTH	7
CLASSIC WALL CAP WITH RADIUS 14"WIDTH	8
CLASSIC WALL CAP WITH RADIUS 16"WIDTH	9
CLASSIC PILASTER CAP - GENERAL DETAILS	10
CLASSIC PILASTER CAP - SIZES, FLAT AND PEAKED	11
CLASSIC PILASTER CAP WITH CENTER HOLE	12
CLASSIC FIRE PIT CAP	13
SONORASTONE® PEAKED WALL CAP - GENERAL DETAILS	14
SONORASTONE® PEAKED WALL CAP - SIZES	15
SONORASTONE® PEAKED PILASTER CAP - SIZES	16
SONORASTONE® FLAT WALL CAP - GENERAL DETAILS	17
SONORASTONE® FLAT WALL CAP - SIZES	18
SONORASTONE® FLAT WALL CAP - GENERAL RADIUSSES	19
SONORASTONE® FLAT WALL CAP WITH RADIUS 7-1/4"WIDTH	20
SONORASTONE® FLAT WALL CAP WITH RADIUS 9-1/4"WIDTH	21
SONORASTONE® FLAT WALL CAP WITH RADIUS 13-1/4"WIDTH	22
SONORASTONE® FLAT PILASTER CAP - SIZES	23
SONORASTONE® LOW WALL SEAT	24
SONORASTONE® FIRE PIT CAP	25
SQUARE MODULAR WALL CAP - STRAIGHT	26
SQUARE MODULAR WALL CAP - CORNER	27
SQUARE MODULAR WALL CAP - END	28
SQUARE MODULAR WALL CAP - RADIUS	29
SQUARE MODULAR PILASTER CAP	30
VENEER	31-33

CLASSIC WALL CAP

8" x 24" x 2-1/2"  
10-1/4" x 24" x 2-1/2"  
12" x 24" x 2-1/2"  
14" x 24" x 2-1/2"  
16" x 24" x 2-1/2"  
24" x 24" x 2-1/2"

CLASSIC PILASTER CAP-FLAT

14" x 14" x 2-1/2"  
16" x 16" x 2-1/2"  
19" x 19" x 2-1/2"  
22" x 22" x 2-1/2"  
24" x 24" x 2-1/2"  
28" x 28" x 2-1/2"

CLASSIC PILASTER CAP-PEAKED

14" x 14" x 3-3/4"  
16" x 16" x 4"  
19" x 19" x 4-1/4"  
22" x 22" x 4-3/8"  
24" x 24" x 4-1/2"  
28" x 28" x 5"

SONORASTONE® WALL CAP-FLAT

10" x 24" x 2-1/2"  
12" x 24" x 2-1/2"  
16" x 24" x 2-1/2"

SONORASTONE® WALL CAP-PEAKED

9-1/4" x 24" x 3"  
12-1/4" x 24" x 3-1/4"  
16-1/4" x 24" x 3-3/4"

SONORASTONE® PILASTER CAP-FLAT

18-1/4" x 18-1/4" x 3"  
24-1/4" x 24-1/4" x 3"  
24-1/4" x 18-1/4" x 3"

SONORASTONE® PILASTER CAP-PEAKED

13-1/4" x 13-1/4" x 3-1/2"  
18-1/4" x 18-1/4" x 4"  
22-1/4" x 22-1/4" x 4-3/8"  
24-1/4" x 24-1/4" x 4-3/4"

SQUARE MODULAR WALL CAP

7-1/4" x 24" x 3-3/8"  
9-1/4" x 24" x 3-3/8"  
13-1/4" x 24" x 3-3/8"  
20-1/4" x 24" x 3-3/8"

SQUARE MODULAR PILASTER CAP

13" x 13" x 3-3/8"  
15" x 15" x 3-3/8"  
20" x 20" x 3-3/8"  
23" x 23" x 3-3/8"  
27" x 27" x 3-3/8"

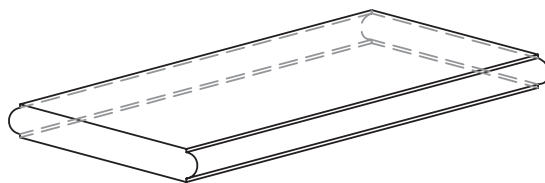
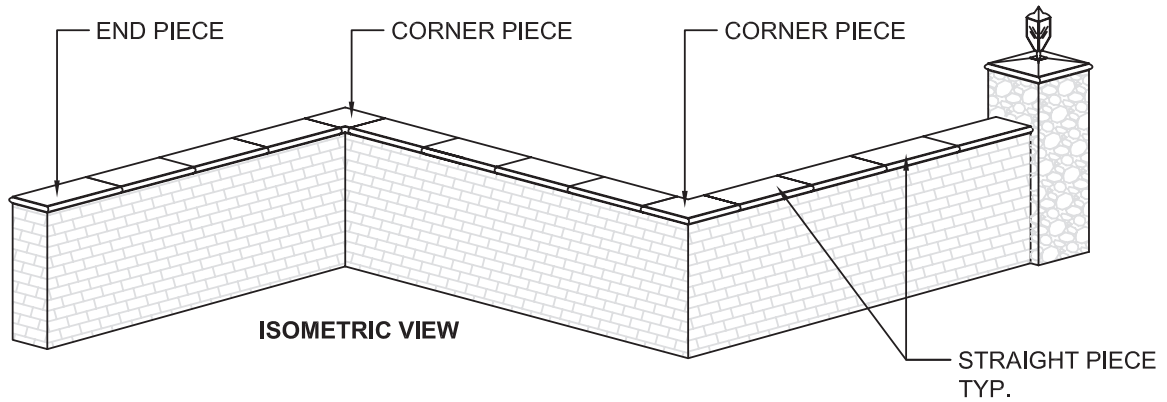

**STRAIGHT PIECE** BULLNOSE: 2 SIDE  
THICKNESS: 2- $\frac{1}{2}$ "  
SIZE: 24"

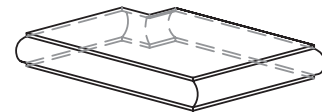

**OUTSIDE PIECE** BULLNOSE: IN & OUT  
THICKNESS: 2- $\frac{1}{2}$ "  
LENGTH: SQUARE  
JOINS W/ STRAIGHT  
PIECES TO FORM  
OUTSIDE CORNERS.

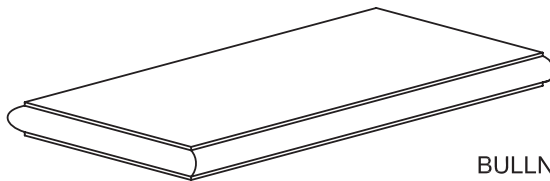

**END PIECE** BULLNOSE: 3 SIDE  
THICKNESS: 2- $\frac{1}{2}$ "  
SIZE: 24"

**NOTES:**

1. PRECAST UNITS ARE INDIVIDUALLY HAND CAST. LENGTHS ARE APPROXIMATE. SOME VARIATIONS ARE EXPECTED.
2. INSTALLATION TO BE COMPLETED IN ACCORDANCE WITH GENERALLY ACCEPTED MASONRY PRACTICE.
3. SMOOTH FINISH ON TOP & NOSE. SANDBLAST FINISH AVAILABLE.
4. PRECAST UNITS MAY BE CUT TO FIT FIELD CONDITIONS.

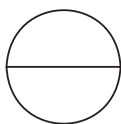

**CLASSIC WALL CAP - GENERAL DETAILS**

SCALE: N.T.S.

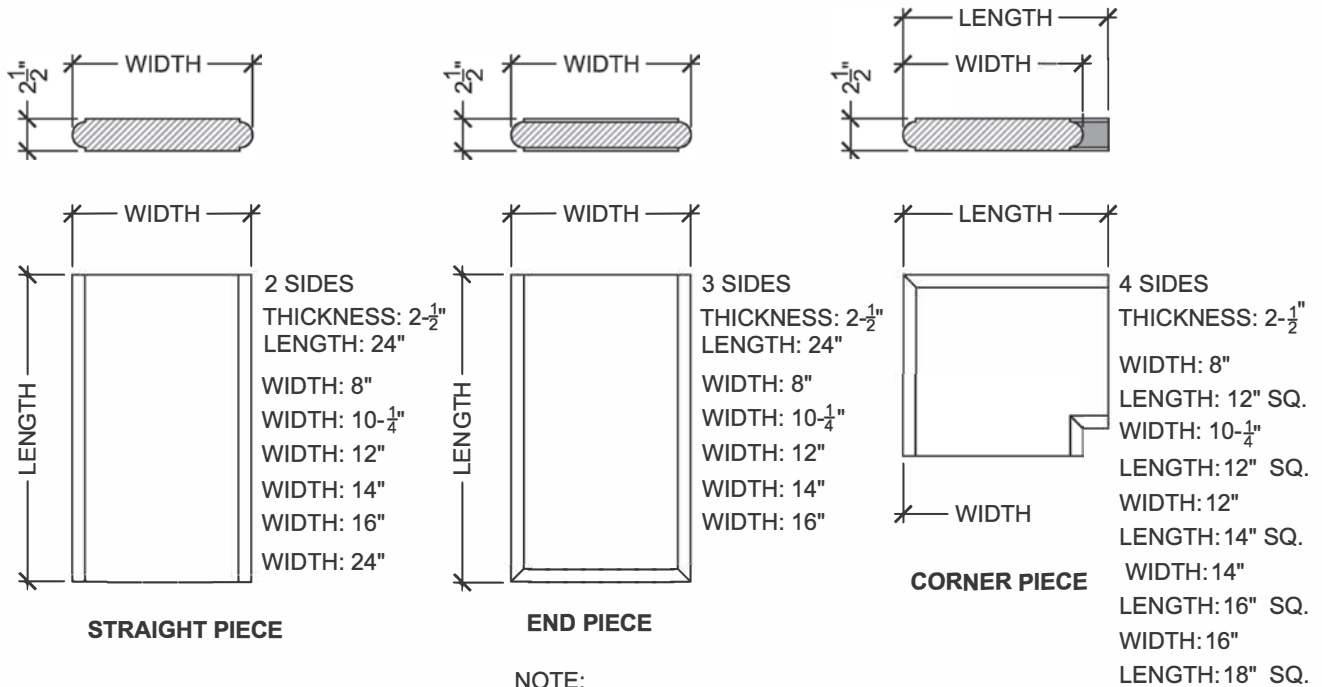
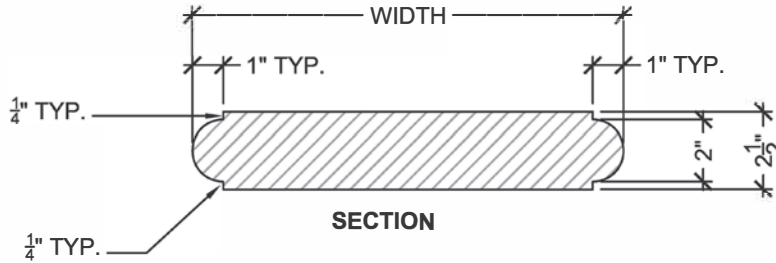

**NOTE:**  
SUGGEST  $\frac{3}{8}$ " JOINT  
BETWEEN PIECES

**NOTES:**

1. PRECAST UNITS ARE INDIVIDUALLY HAND CAST. LENGTHS ARE APPROXIMATE. SOME VARIATIONS ARE EXPECTED.
2. INSTALLATION TO BE COMPLETED IN ACCORDANCE WITH GENERALLY ACCEPTED MASONRY PRACTICE.
3. SMOOTH FINISH ON TOP & NOSE. SANDBLAST FINISH AVAILABLE.
4. PRECAST UNITS MAY BE CUT TO FIT FIELD CONDITIONS.



**CLASSIC WALL CAP - SIZES**  
SCALE: N.T.S.

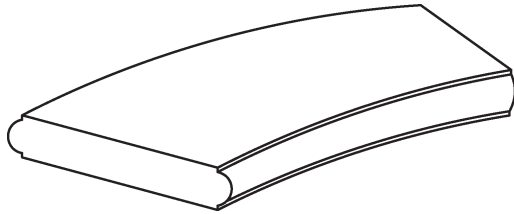

**10 1/4" WIDTH, 2 SIDE BULLNOSE**

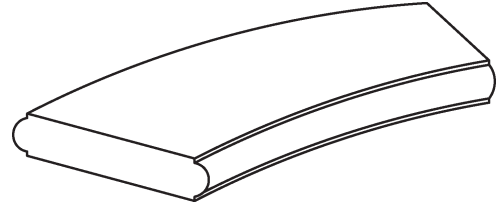

**12" WIDTH, 2 SIDE BULLNOSE**

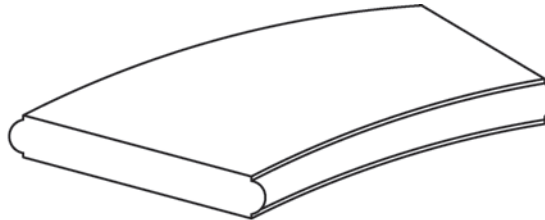

**14" WIDTH, 2 SIDE BULLNOSE**

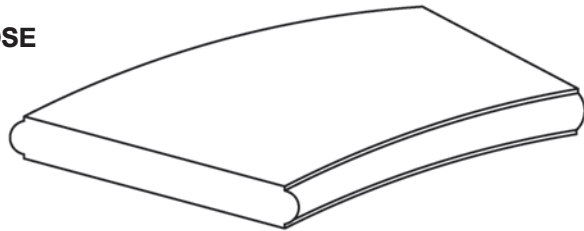

**16" WIDTH, 2 SIDE BULLNOSE**

**NOTES:**

1. PRECAST UNITS ARE INDIVIDUALLY HAND CAST. LENGTHS ARE APPROXIMATE. SOME VARIATIONS ARE EXPECTED.
2. INSTALLATION TO BE COMPLETED IN ACCORDANCE WITH GENERALLY ACCEPTED MASONRY PRACTICE.
3. SMOOTH FINISH ON TOP & NOSE. SANDBLAST FINISH AVAILABLE.
4. PRECAST UNITS MAY BE CUT TO FIT FIELD CONDITIONS.

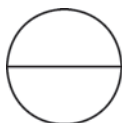

**CLASSIC WALL CAP - GENERAL RADIUS**

SCALE: N.T.S.

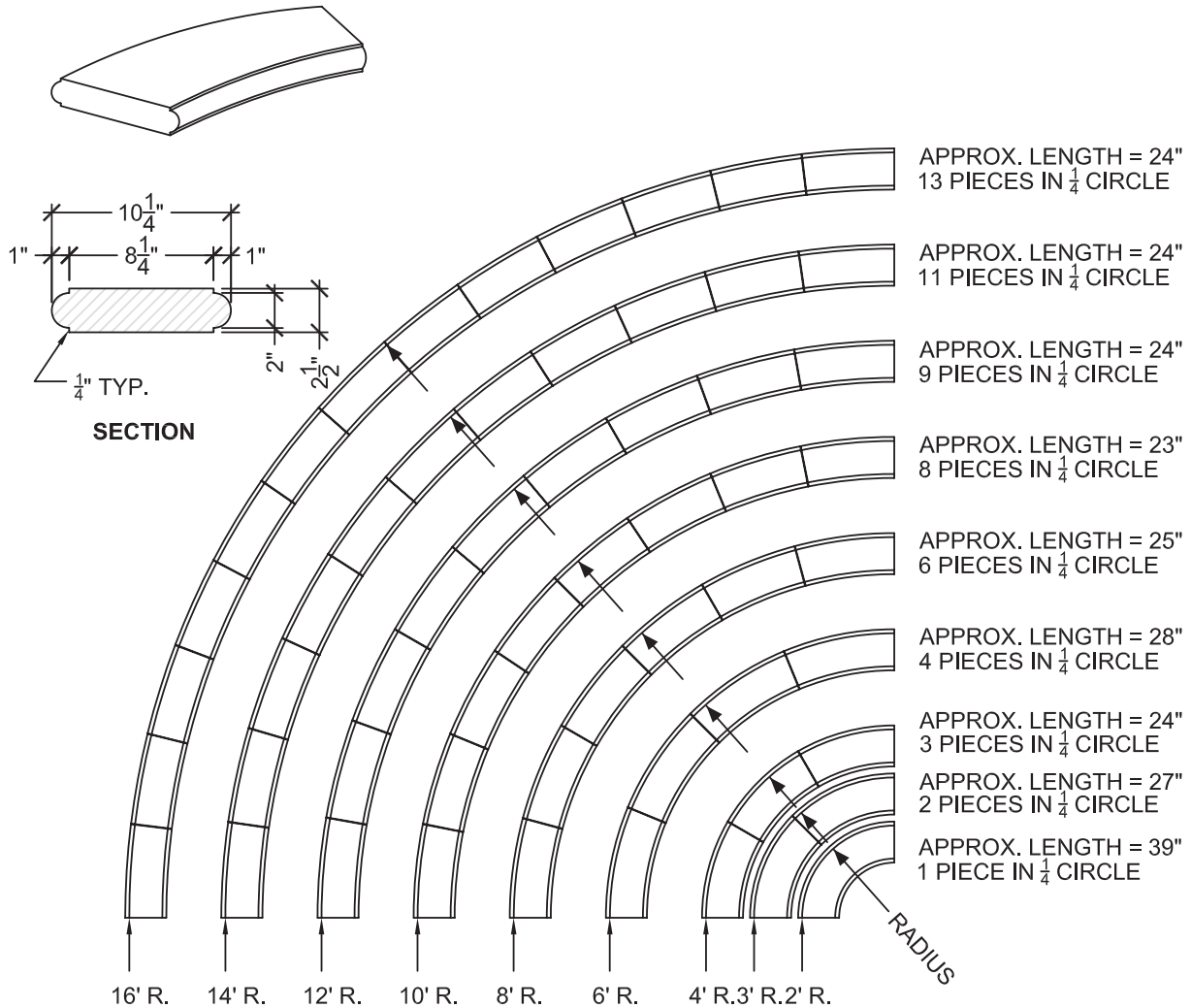

**NOTES:**

1. PRECAST UNITS ARE INDIVIDUALLY HAND CAST. LENGTHS ARE APPROXIMATE. SOME VARIATIONS ARE EXPECTED.
2. INSTALLATION TO BE COMPLETED IN ACCORDANCE WITH GENERALLY ACCEPTED MASONRY PRACTICE.
3. SMOOTH FINISH ON TOP & NOSE. SANDBLAST FINISH AVAILABLE.
4. PRECAST UNITS MAY BE CUT TO FIT FIELD CONDITIONS.

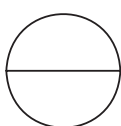

**CLASSIC WALL CAP RADIUS - 10-1/4" WIDTH**

SCALE: N.T.S.

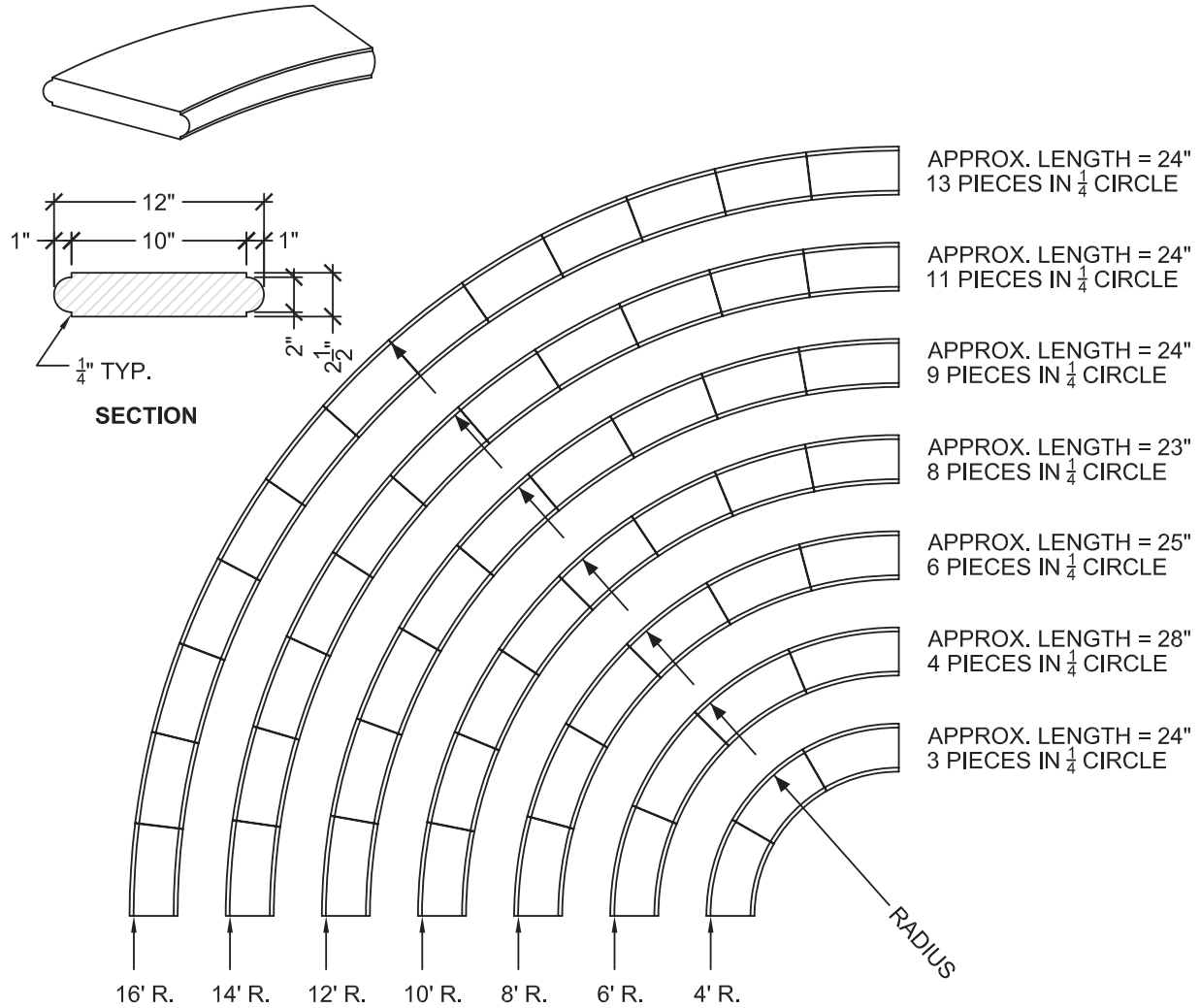

**NOTES:**

1. PRECAST UNITS ARE INDIVIDUALLY HAND CAST. LENGTHS ARE APPROXIMATE. SOME VARIATIONS ARE EXPECTED.
2. INSTALLATION TO BE COMPLETED IN ACCORDANCE WITH GENERALLY ACCEPTED MASONRY PRACTICE.
3. SMOOTH FINISH ON TOP & NOSE. SANDBLAST FINISH AVAILABLE.
4. PRECAST UNITS MAY BE CUT TO FIT FIELD CONDITIONS.

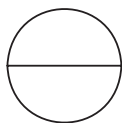

**CLASSIC WALL CAP RADIUS - 12" WIDTH**

SCALE: N.T.S.

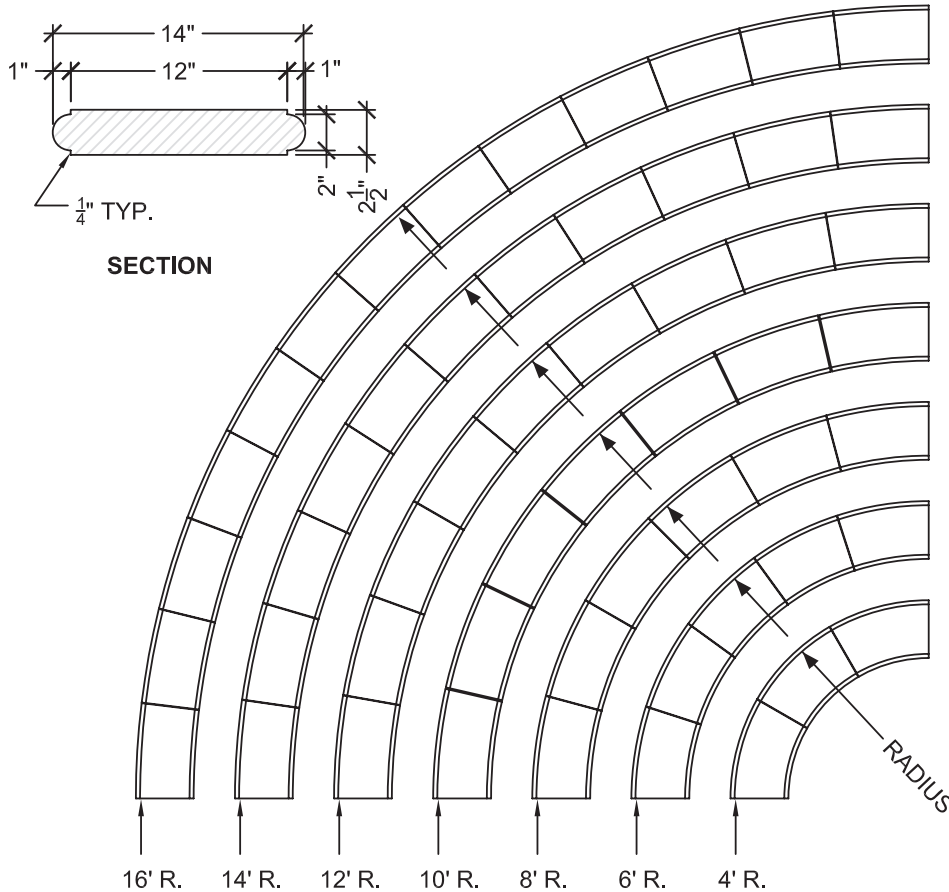
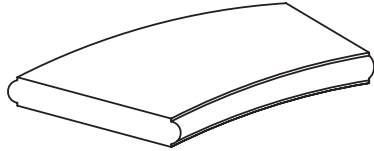

**NOTES:**

1. PRECAST UNITS ARE INDIVIDUALLY HAND CAST. LENGTHS ARE APPROXIMATE. SOME VARIATIONS ARE EXPECTED.
2. INSTALLATION TO BE COMPLETED IN ACCORDANCE WITH GENERALLY ACCEPTED MASONRY PRACTICE.
3. SMOOTH FINISH ON TOP & NOSE. SANDBLAST FINISH AVAILABLE.
4. PRECAST UNITS MAY BE CUT TO FIT FIELD CONDITIONS.

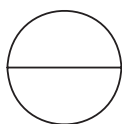

**CLASSIC WALL CAP RADIUS - 14" WIDTH**

SCALE: N.T.S.



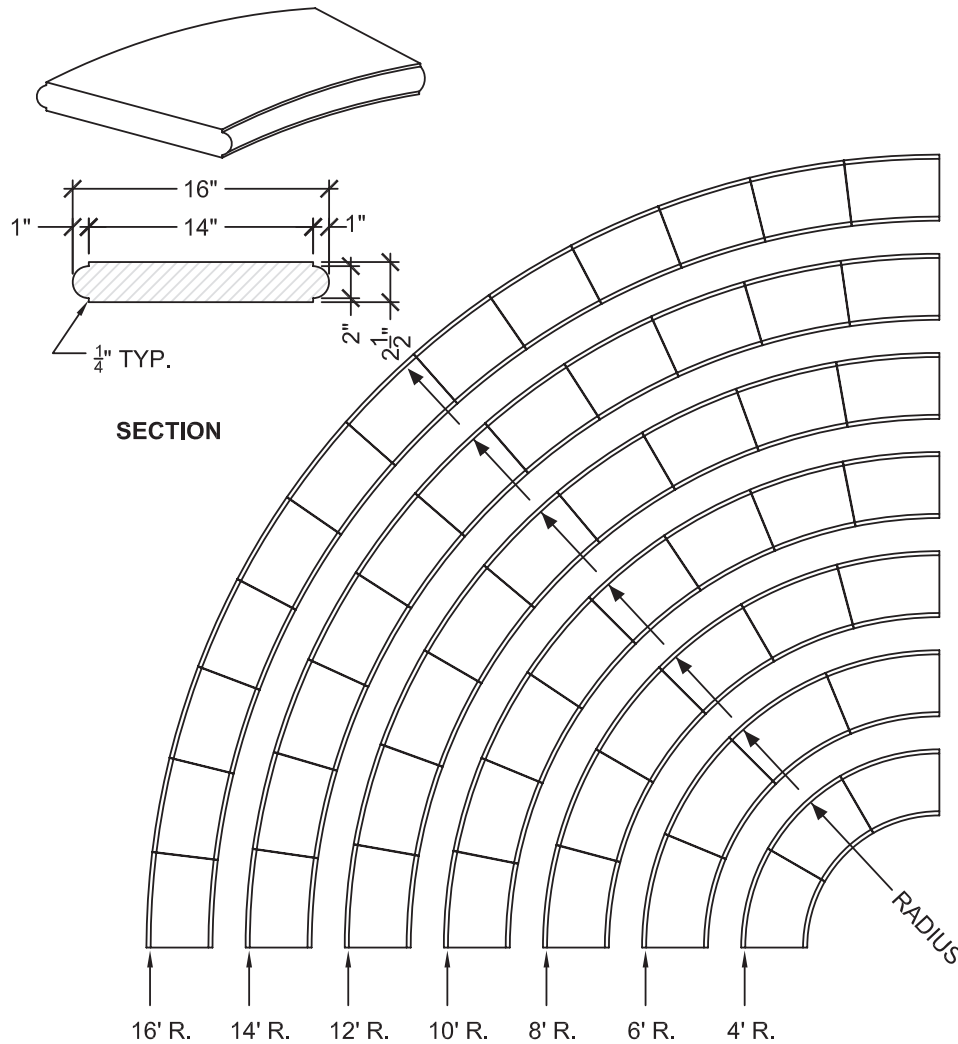

APPROX. LENGTH = 24"  
13 PIECES IN  $\frac{1}{4}$  CIRCLE

APPROX. LENGTH = 24"  
11 PIECES IN  $\frac{1}{4}$  CIRCLE

APPROX. LENGTH = 24"  
9 PIECES IN  $\frac{1}{4}$  CIRCLE

APPROX. LENGTH = 23"  
8 PIECES IN  $\frac{1}{4}$  CIRCLE

APPROX. LENGTH = 25"  
6 PIECES IN  $\frac{1}{4}$  CIRCLE

APPROX. LENGTH = 28"  
4 PIECES IN  $\frac{1}{4}$  CIRCLE

APPROX. LENGTH = 24"  
3 PIECES IN  $\frac{1}{4}$  CIRCLE

**NOTES:**

1. PRECAST UNITS ARE INDIVIDUALLY HAND CAST. LENGTHS ARE APPROXIMATE. SOME VARIATIONS ARE EXPECTED.
2. INSTALLATION TO BE COMPLETED IN ACCORDANCE WITH GENERALLY ACCEPTED MASONRY PRACTICE.
3. SMOOTH FINISH ON TOP & NOSE. SANDBLAST FINISH AVAILABLE.
4. PRECAST UNITS MAY BE CUT TO FIT FIELD CONDITIONS.

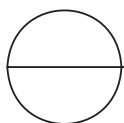

**CLASSIC WALL CAP RADIUS - 16" WIDTH**

SCALE: N.T.S.

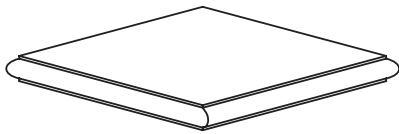
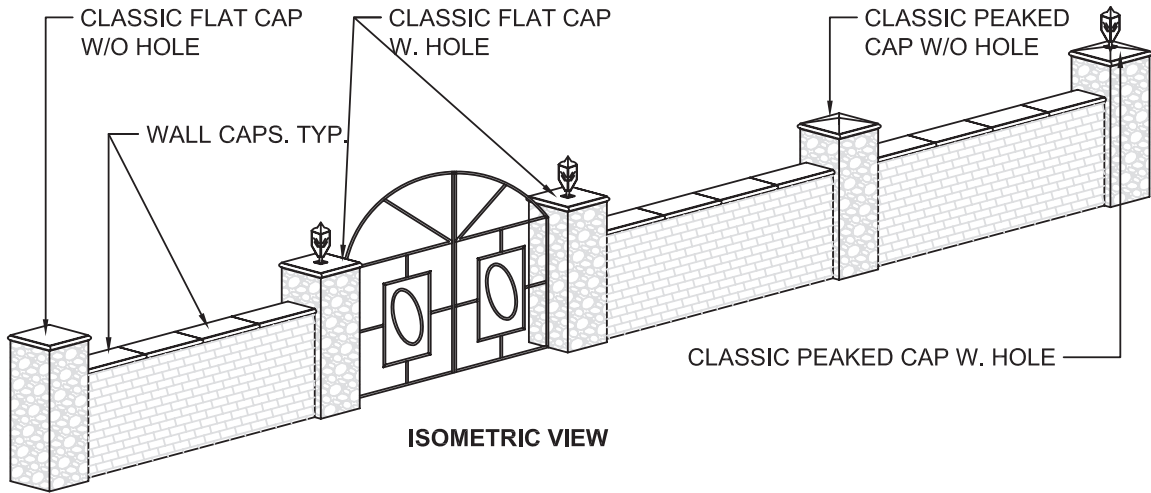

BULLNOSE: 4 SIDE  
THICKNESS: 2-<sup>1</sup>/<sub>2</sub>"  
SQUARE. TYP.

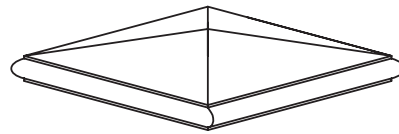

BULLNOSE: 4 SIDE  
THICKNESS: VARIES  
SQUARE. TYP.

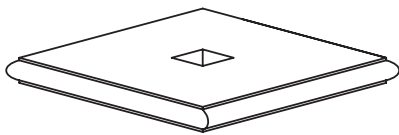

FLAT CAPS

HOLE IN CENTER  
OF CAP, 2-<sup>1</sup>/<sub>2</sub>" x 2-<sup>1</sup>/<sub>2</sub>"

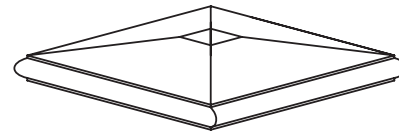

PEAKED CAPS

HOLE IN CENTER  
OF CAP, 2-<sup>1</sup>/<sub>2</sub>" x 2-<sup>1</sup>/<sub>2</sub>"

**NOTES:**

1. PRECAST UNITS ARE INDIVIDUALLY HAND CAST. LENGTHS ARE APPROXIMATE. SOME VARIATIONS ARE EXPECTED.
2. INSTALLATION TO BE COMPLETED IN ACCORDANCE WITH GENERALLY ACCEPTED MASONRY PRACTICE.
3. SMOOTH FINISH ON TOP AND NOSE. SANDBLAST FINISH AVAILABLE.
4. PRECAST UNITS MAY BE CUT TO FIT FIELD CONDITIONS.

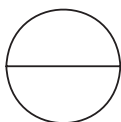

**CLASSIC PILASTER CAP GENERAL DETAILS**

SCALE: N.T.S.

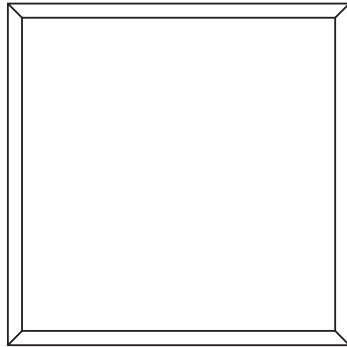
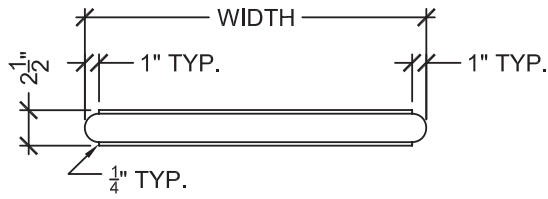

BULLNOSE: 4 SIDE  
THICKNESS: 2- $\frac{1}{2}$ "  
SQUARE. TYP.

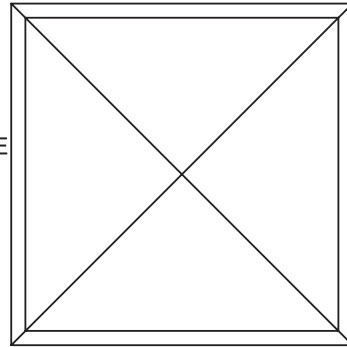
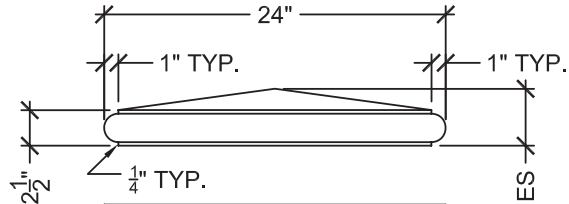

BULLNOSE: 4 SIDE  
THICKNESS: VARIES  
SQUARE. TYP.

SELECT DESIRED QTY. FLAT

WIDTH 14" x 14" SQ.

WIDTH 16" x 16" SQ.

WIDTH 19" x 19" SQ.

WIDTH 22" x 22" SQ.

WIDTH 24" x 24" SQ.

WIDTH 28" x 28" SQ.

SELECT DESIRED QTY. PEAKED

WIDTH 14" x 14" SQ. (THICK, 3- $\frac{3}{4}$ ")

WIDTH 16" x 16" SQ. (THICK, 4")

WIDTH 19" x 19" SQ. (THICK, 4- $\frac{1}{4}$ ")

WIDTH 22" x 22" SQ. (THICK, 4- $\frac{3}{8}$ ")

WIDTH 24" x 24" SQ. (THICK, 4- $\frac{1}{2}$ ")

WIDTH 28" x 28" SQ. (THICK, 5")

**NOTES:**

1. PRECAST UNITS ARE INDIVIDUALLY HAND CAST. LENGTHS ARE APPROXIMATE. SOME VARIATIONS ARE EXPECTED.
2. INSTALLATION TO BE COMPLETED IN ACCORDANCE WITH GENERALLY ACCEPTED MASONRY PRACTICE.
3. SMOOTH FINISH ON TOP AND NOSE. SANDBLAST FINISH AVAILABLE.
4. PRECAST UNITS MAY BE CUT TO FIT FIELD CONDITIONS.

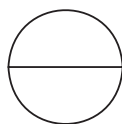

**CLASSIC PILASTER CAP SIZES, FLAT AND PEAKED**

SCALE: N.T.S.

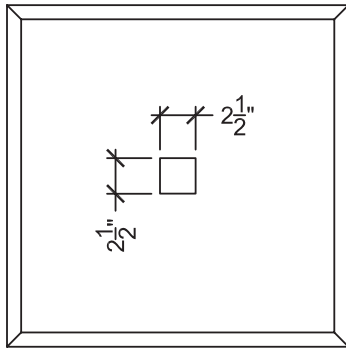
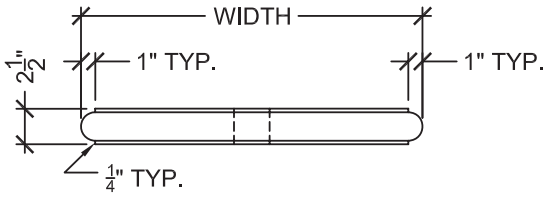

BULLNOSE: 4 SIDE  
THICKNESS: 2- $\frac{1}{2}$ "  
SQUARE. TYP.

SELECT DESIRED QTY. FLAT

- WIDTH 14" x 14" SQ.
- WIDTH 16" x 16" SQ.
- WIDTH 19" x 19" SQ.
- WIDTH 22" x 22" SQ.
- WIDTH 24" x 24" SQ.
- WIDTH 28" x 28" SQ.

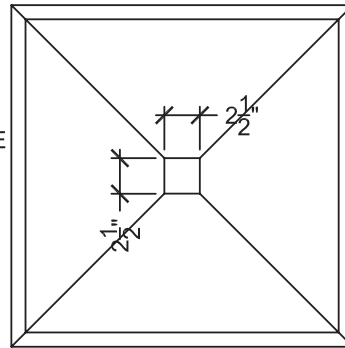
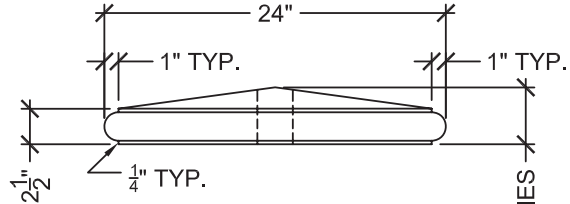

BULLNOSE: 4 SIDE  
THICKNESS: VARIES  
SQUARE. TYP.

SELECT DESIRED QTY. PEAKED

- WIDTH 14" x 14" SQ. (THICK, 3- $\frac{3}{4}$ ")
- WIDTH 16" x 16" SQ. (THICK, 4")
- WIDTH 19" x 19" SQ. (THICK, 4- $\frac{1}{4}$ ")
- WIDTH 22" x 22" SQ. (THICK, 4- $\frac{3}{8}$ ")
- WIDTH 24" x 24" SQ. (THICK, 4- $\frac{1}{2}$ ")
- WIDTH 28" x 28" SQ. (THICK, 5")

NOTES:

1. PRECAST UNITS ARE INDIVIDUALLY HAND CAST. LENGTHS ARE APPROXIMATE. SOME VARIATIONS ARE EXPECTED.
2. INSTALLATION TO BE COMPLETED IN ACCORDANCE WITH GENERALLY ACCEPTED MASONRY PRACTICE.
3. SMOOTH FINISH ON TOP AND NOSE. SANDBLAST FINISH AVAILABLE.
4. PRECAST UNITS MAY BE CUT TO FIT FIELD CONDITIONS.
5. CENTER HOLE IS STANDARD 2- $\frac{1}{2}$ " x 2- $\frac{1}{2}$ ", CUSTOM HOLE AVAILABLE.

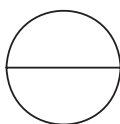

## CLASSIC PILASTER CAP WITH CENTER HOLE

SCALE: N.T.S.

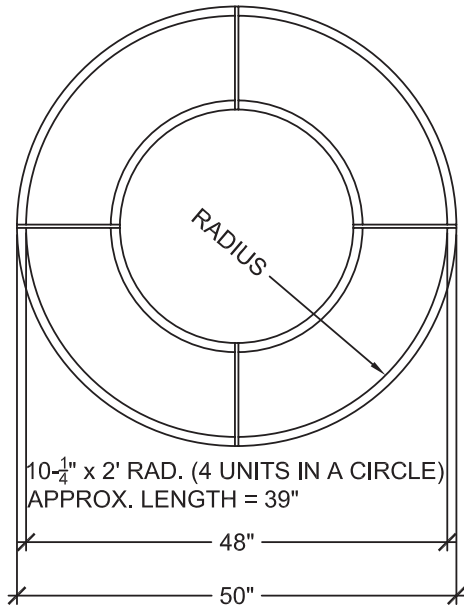

TOP VIEW

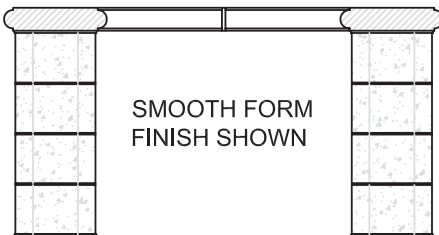

SIDE VIEW

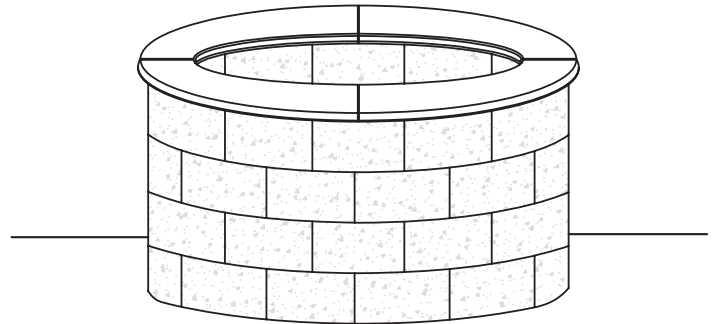
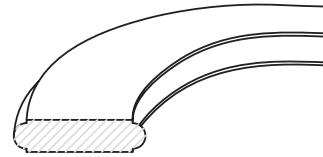
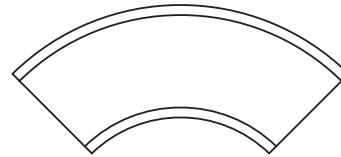
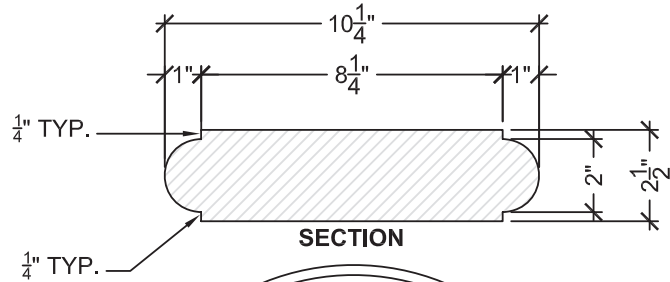

**NOTES:**

1. PRECAST UNITS ARE INDIVIDUALLY HAND CAST. LENGTHS ARE APPROXIMATE. SOME VARIATIONS ARE EXPECTED.
2. INSTALLATION TO BE COMPLETED IN ACCORDANCE WITH GENERALLY ACCEPTED MASONRY PRACTICES.
3. SMOOTH FINISH ON TOP & NOSE. SANDBLAST FINISH AVAILABLE.
4. PRECAST UNITS MAY BE CUT TO FIT FIELD CONDITIONS.
5. WE DO NOT RECOMMEND THE USE OF OUR CONCRETE PRODUCTS IN ENVIRONMENTS THAT WILL HEAT THE CONCRETE TO MORE THAN 200 DEGRESS. DIRECT EXPOSURE TO A FIRE'S FLAME FOR AN EXTENDED PERIOD OF TIME WILL DAMAGE THE CONCRETE. INSTALLATIONS SUBJECTING STEPSTONE'S PRECAST PIECES TO EXCESSIVE HEAT WILL VOID THE MANUFACTURER'S WARRANTY AND STEPSTONE, INC WILL NOT REPLACE ANY DAMAGED PRODUCT.

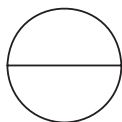

**CLASSIC FIRE PIT CAP**

SCALE: N.T.S.

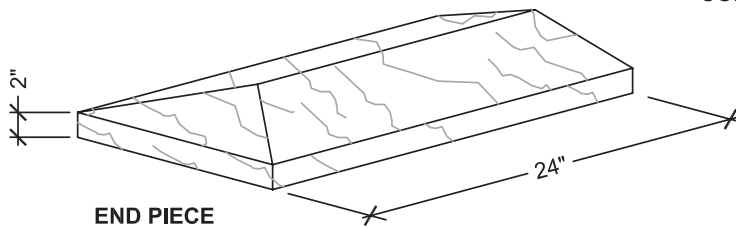
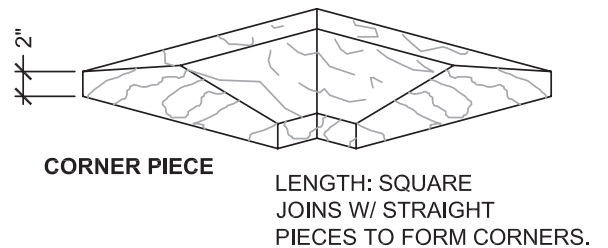
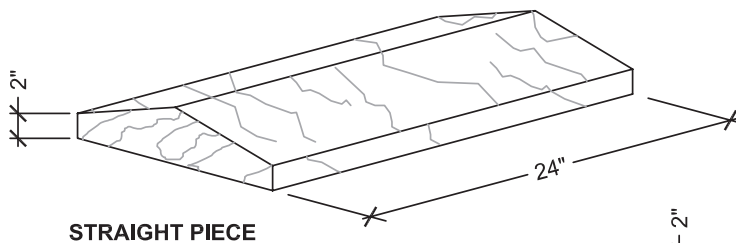
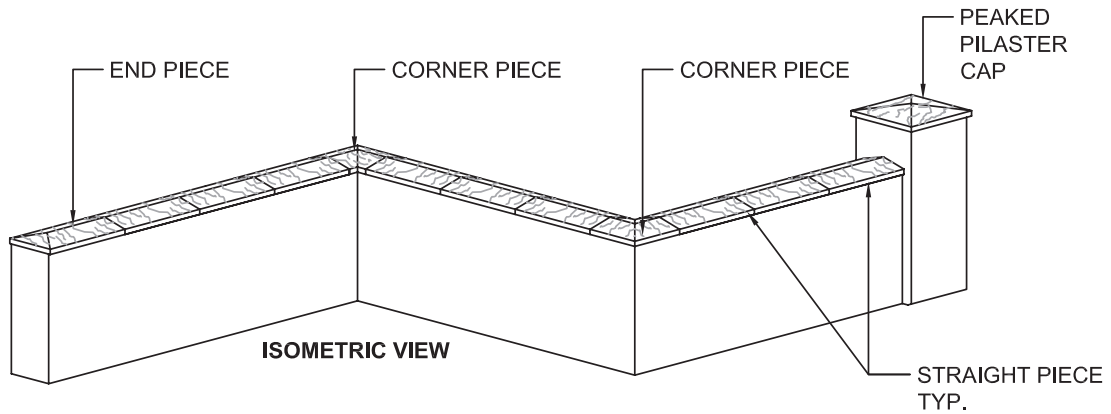

**NOTES:**

1. PRECAST UNITS ARE INDIVIDUALLY HAND CAST. LENGTHS ARE APPROXIMATE. SOME VARIATIONS ARE EXPECTED.
2. INSTALLATION TO BE COMPLETED IN ACCORDANCE WITH GENERALLY ACCEPTED MASONRY PRACTICE.
3. SONORASTONE® FINISH ON TOP & SIDES.
4. PRECAST UNITS MAY BE CUT TO FIT FIELD CONDITIONS.

**SONORASTONE® PEAKED WALL CAP -  
GENERAL DETAILS**

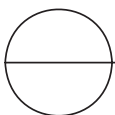

SCALE: N.T.S.

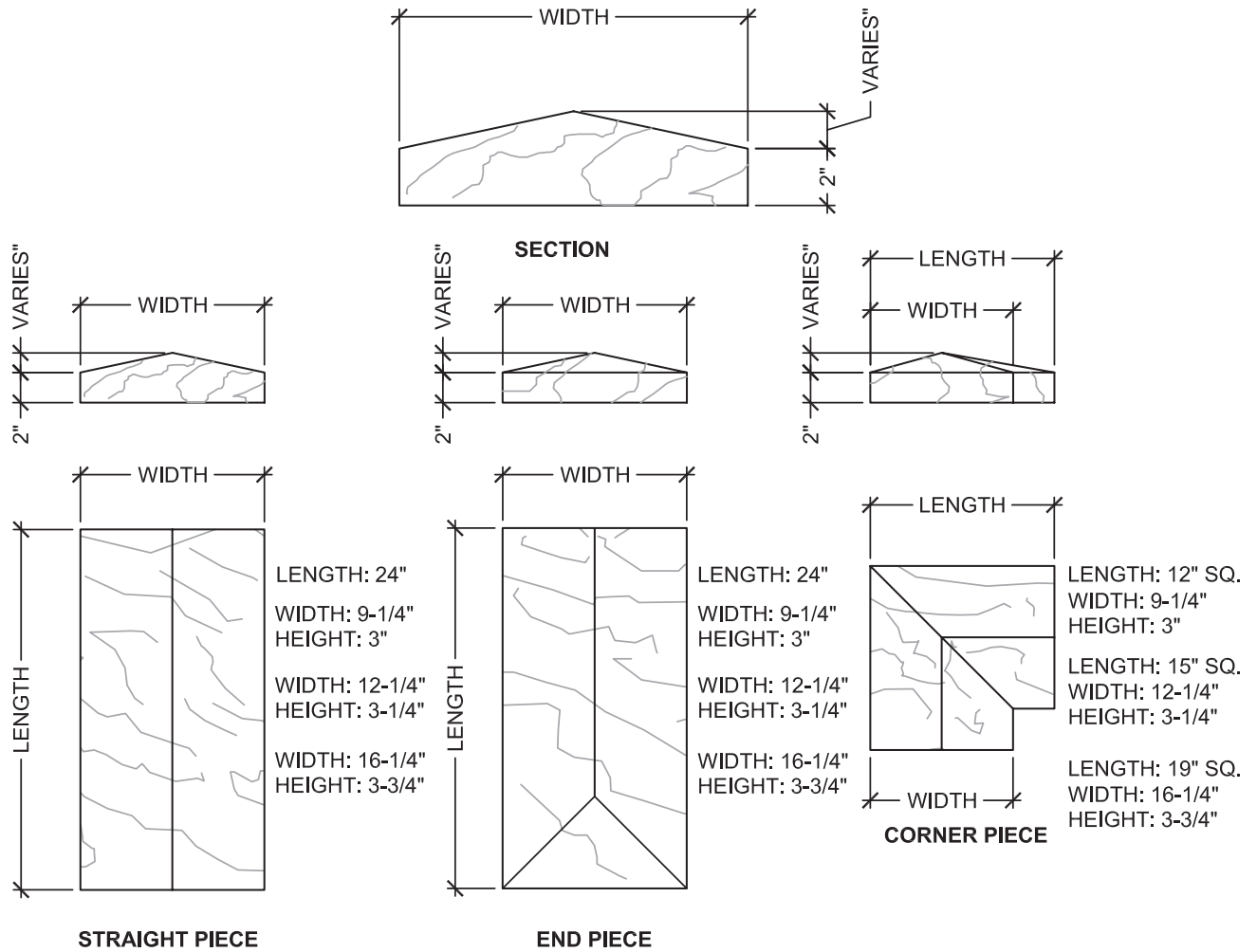

**NOTES:**

1. PRECAST UNITS ARE INDIVIDUALLY HAND CAST. LENGTHS ARE APPROXIMATE. SOME VARIATIONS ARE EXPECTED.
2. INSTALLATION TO BE COMPLETED IN ACCORDANCE WITH GENERALLY ACCEPTED MASONRY PRACTICE.
3. SONORASTONE® FINISH ON TOP & SIDES.
4. PRECAST UNITS MAY BE CUT TO FIT FIELD CONDITIONS.

 **SONORASTONE® PEAKED WALL CAP - SIZES**  
SCALE: N.T.S.

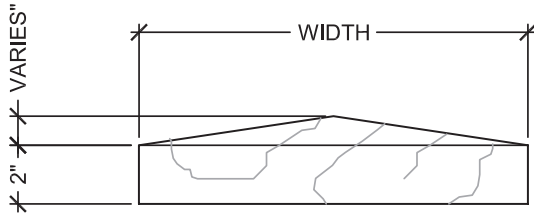

SIDE

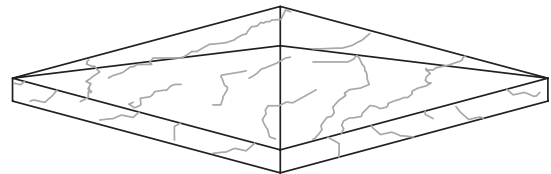

ISOMETRIC

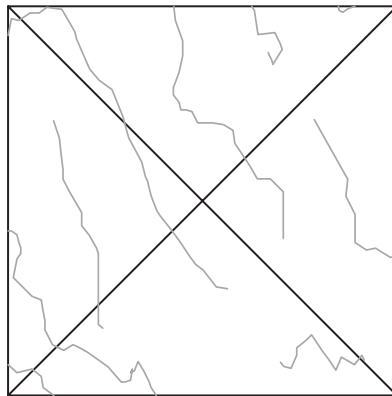

TOP

LENGTH: SQUARE

SIZE: 13-1/4" SQ.	HEIGHT: 3-1/2"
SIZE: 18-1/4" SQ.	HEIGHT: 4"
SIZE: 22-1/4" SQ.	HEIGHT: 4-3/8"
SIZE: 24-1/4" SQ.	HEIGHT: 4-3/4"

**NOTES:**

1. PRECAST UNITS ARE INDIVIDUALLY HAND CAST. LENGTHS ARE APPROXIMATE. SOME VARIATIONS ARE EXPECTED.
2. INSTALLATION TO BE COMPLETED IN ACCORDANCE WITH GENERALLY ACCEPTED MASONRY PRACTICE.
3. SONORASTONE® FINISH ON TOP & SIDES.
4. PRECAST UNITS MAY BE CUT TO FIT FIELD CONDITIONS.

**SONORASTONE® PEAKED  
PILASTER CAP - SIZES**

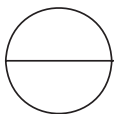

SCALE: N.T.S.



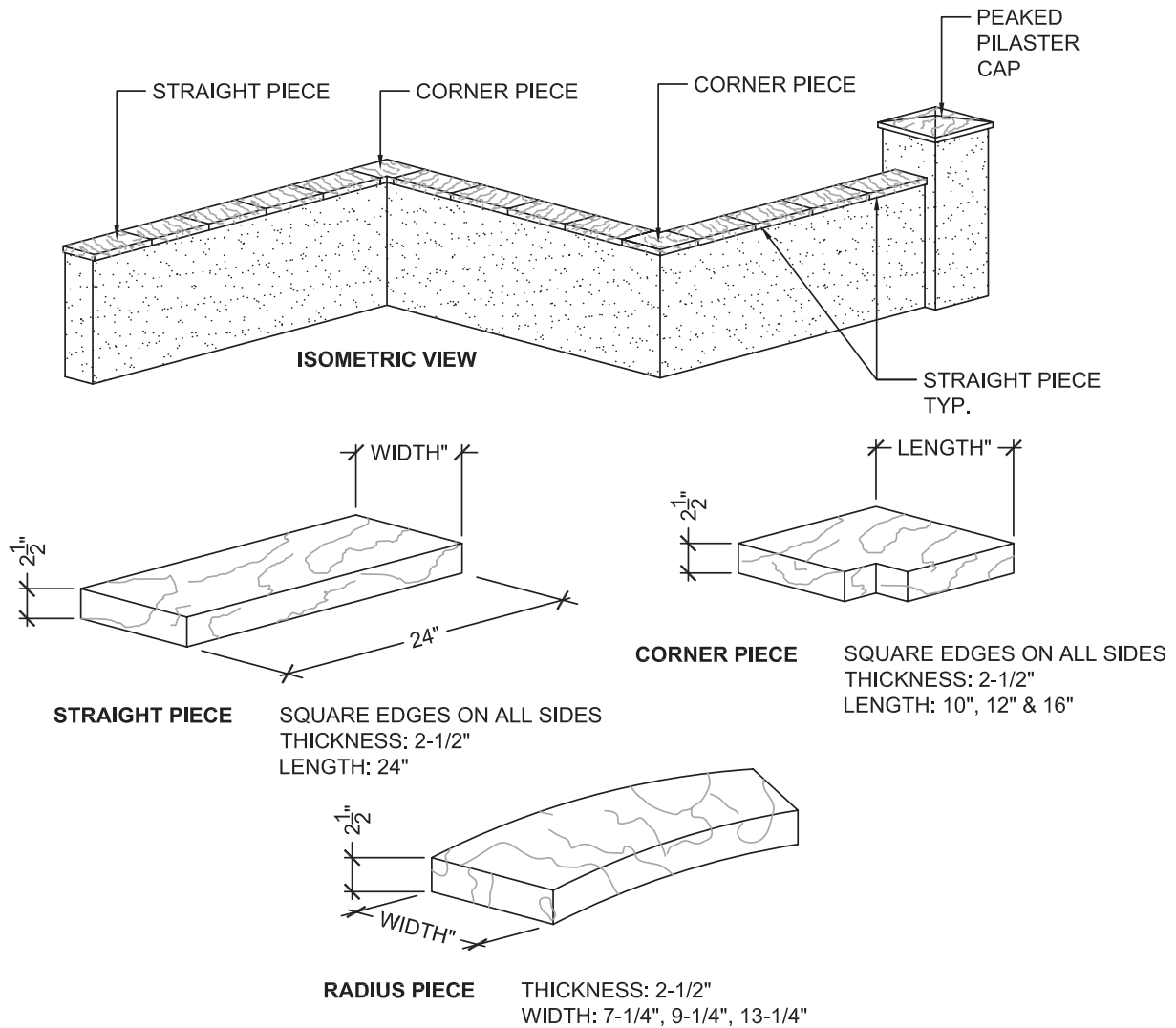

**NOTES:**

1. PRECAST UNITS ARE INDIVIDUALLY HAND CAST. LENGTHS ARE APPROXIMATE. SOME VARIATIONS ARE EXPECTED.
2. INSTALLATION TO BE COMPLETED IN ACCORDANCE WITH GENERALLY ACCEPTED MASONRY PRACTICE.
3. SONORASTONE® FINISH ON TOP & SIDES.
4. PRECAST UNITS MAY BE CUT TO FIT FIELD CONDITIONS.

# SONORASTONE® FLAT WALL CAP - GENERAL DETAILS

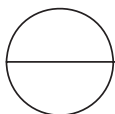

SCALE: N.T.S.

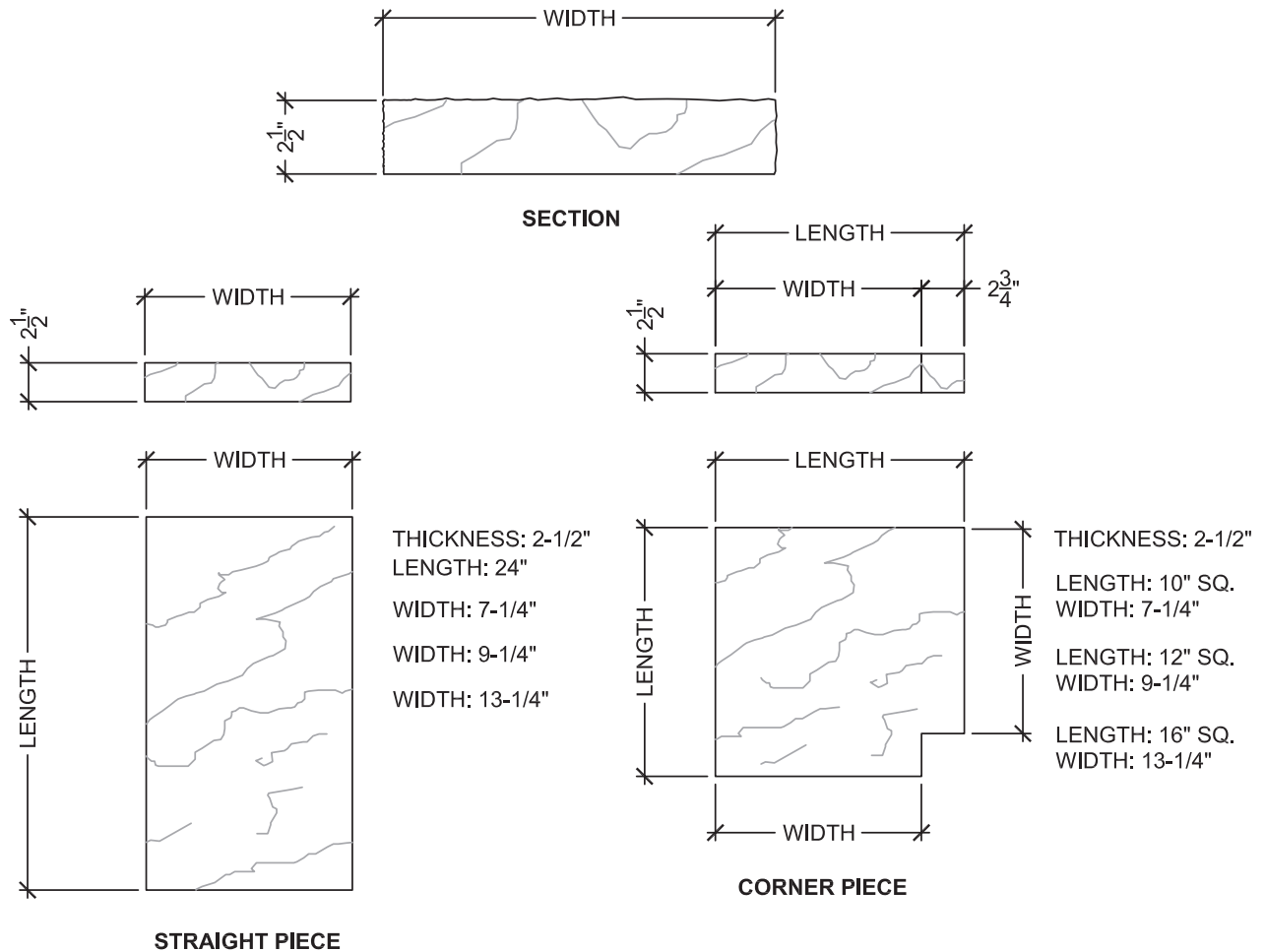

**NOTES:**

1. PRECAST UNITS ARE INDIVIDUALLY HAND CAST. LENGTHS ARE APPROXIMATE. SOME VARIATIONS ARE EXPECTED.
2. INSTALLATION TO BE COMPLETED IN ACCORDANCE WITH GENERALLY ACCEPTED MASONRY PRACTICE.
3. SONORASTONE® FINISH ON TOP & SIDES.
4. PRECAST UNITS MAY BE CUT TO FIT FIELD CONDITIONS.

 **SONORASTONE® FLAT WALL CAP - SIZES**  
SCALE: N.T.S.

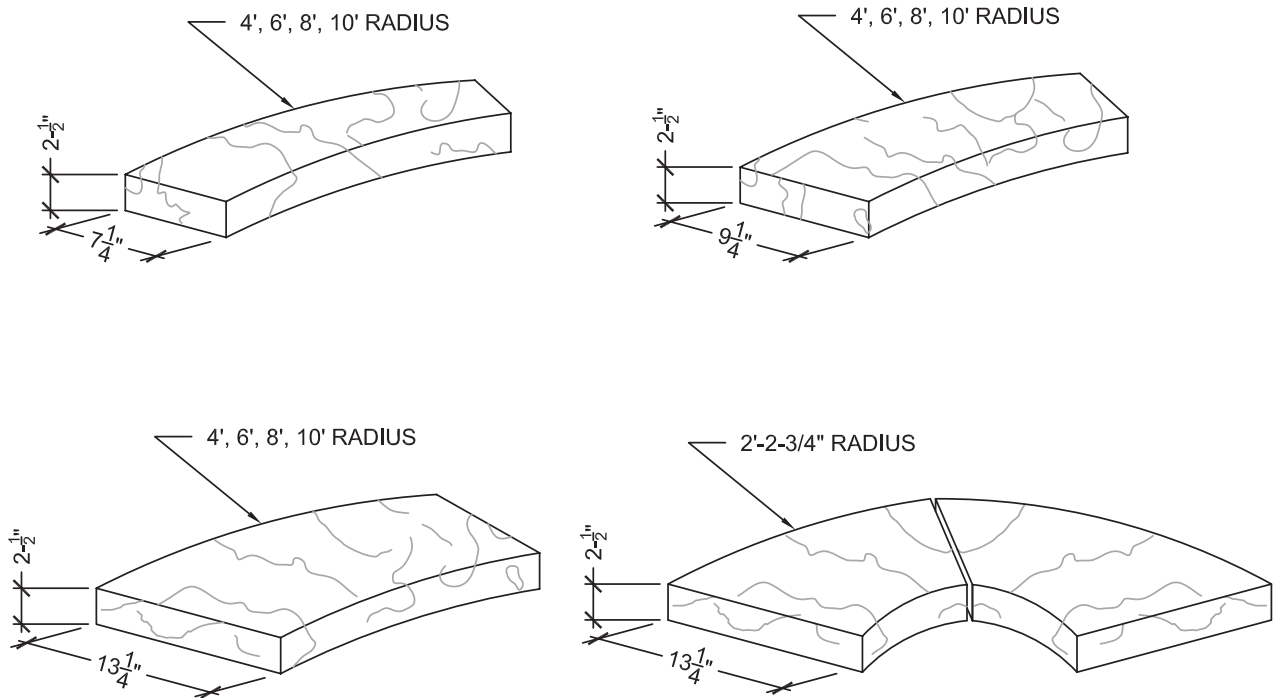

**NOTES:**

1. PRECAST UNITS ARE INDIVIDUALLY HAND CAST. LENGTHS ARE APPROXIMATE. SOME VARIATIONS ARE EXPECTED.
2. INSTALLATION TO BE COMPLETED IN ACCORDANCE WITH GENERALLY ACCEPTED MASONRY PRACTICE.
3. SONORASTONE® FINISH ON TOP & SIDES.
4. PRECAST UNITS MAY BE CUT TO FIT FIELD CONDITIONS.

SONORASTONE® FLAT WALL CAP  
GENERAL RADIUS

---

SCALE: N.T.S.

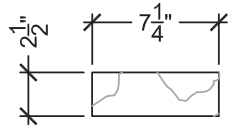

**SECTION**

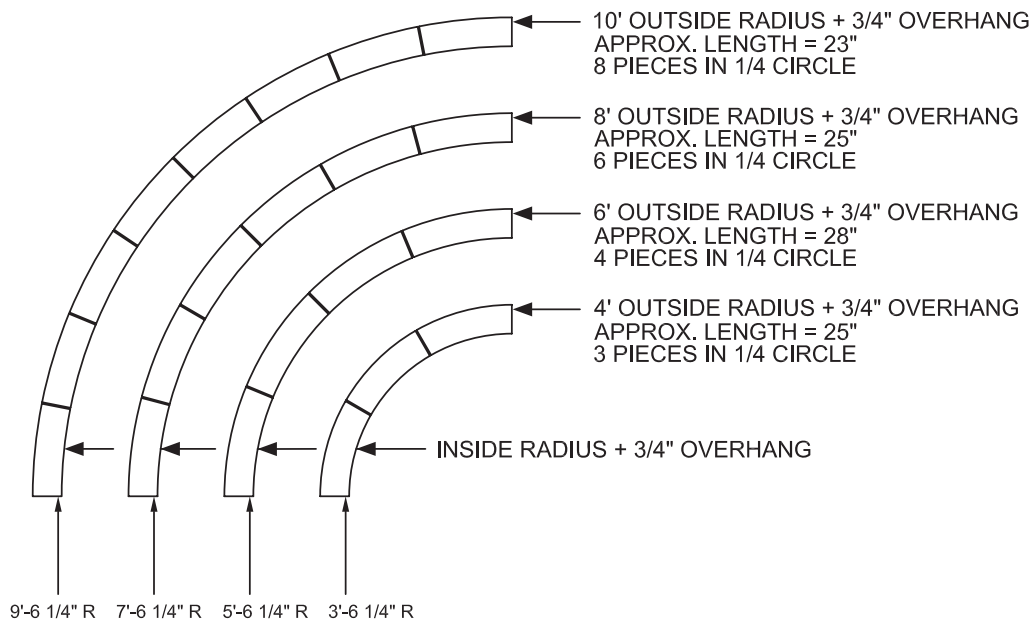
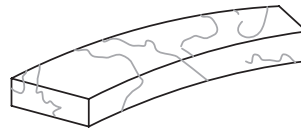

**NOTES:**

1. PRECAST UNITS ARE INDIVIDUALLY HAND CAST. LENGTHS ARE APPROXIMATE. SOME VARIATIONS ARE EXPECTED.
2. INSTALLATION TO BE COMPLETED IN ACCORDANCE WITH GENERALLY ACCEPTED MASONRY PRACTICE.
3. SONORASTONE® FINISH ON TOP & SIDES.
4. PRECAST UNITS MAY BE CUT TO FIT FIELD CONDITIONS.

**SONORASTONE® FLAT WALL CAP**  
**RADIUS 7-1/4" WIDTH**

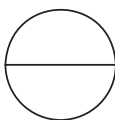

SCALE: N.T.S.

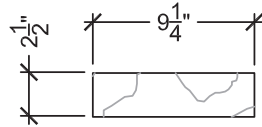

SECTION

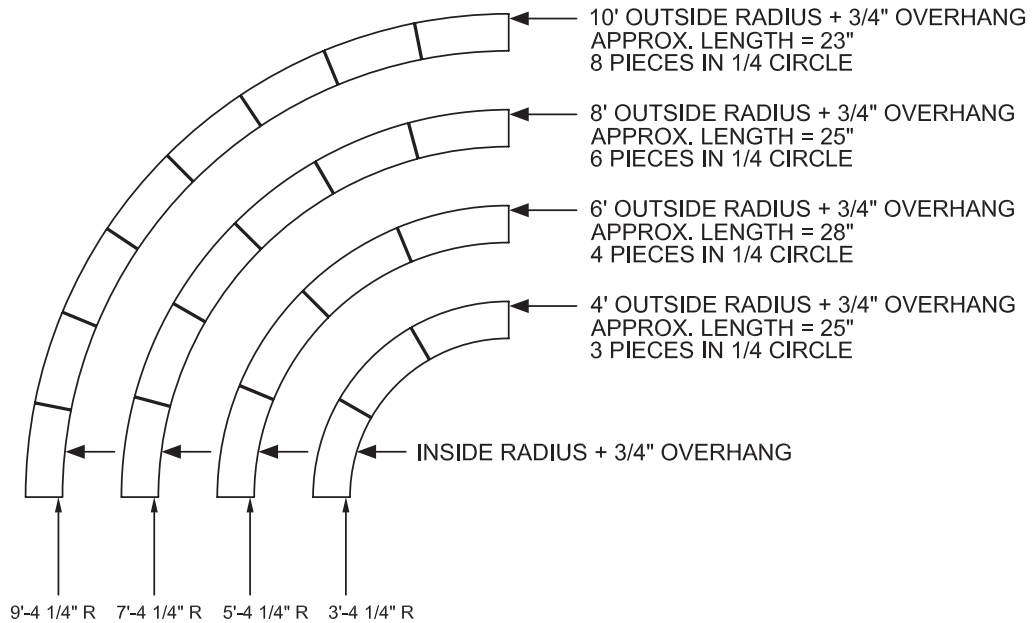
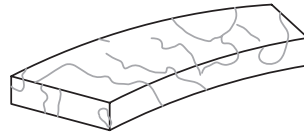

**NOTES:**

1. PRECAST UNITS ARE INDIVIDUALLY HAND CAST. LENGTHS ARE APPROXIMATE. SOME VARIATIONS ARE EXPECTED.
2. INSTALLATION TO BE COMPLETED IN ACCORDANCE WITH GENERALLY ACCEPTED MASONRY PRACTICE.
3. SONORASTONE® FINISH ON TOP & SIDES.
4. PRECAST UNITS MAY BE CUT TO FIT FIELD CONDITIONS.

**SONORASTONE® FLAT WALL CAP**  
**RADIUS 9-1/4" WIDTH**

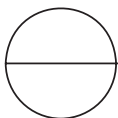

SCALE: N.T.S.

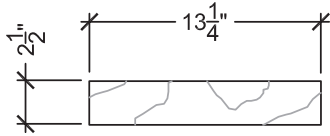

SECTION

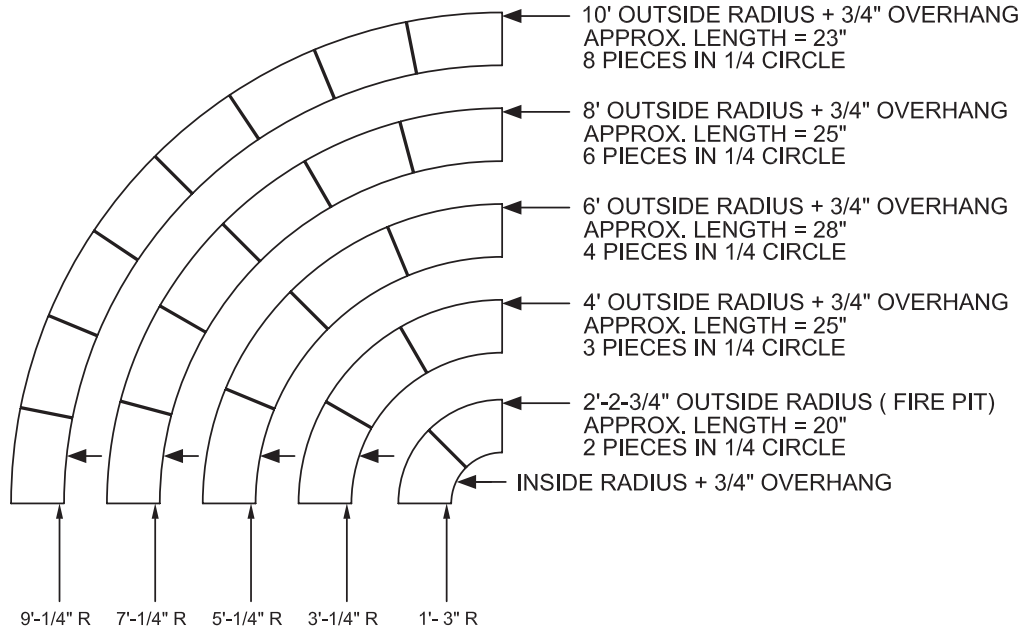
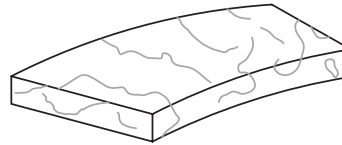

**NOTES:**

1. PRECAST UNITS ARE INDIVIDUALLY HAND CAST. LENGTHS ARE APPROXIMATE. SOME VARIATIONS ARE EXPECTED.
2. INSTALLATION TO BE COMPLETED IN ACCORDANCE WITH GENERALLY ACCEPTED MASONRY PRACTICE.
3. SONORASTONE® FINISH ON TOP & SIDES.
4. PRECAST UNITS MAY BE CUT TO FIT FIELD CONDITIONS.

**SONORASTONE® FLAT WALL CAP**  
**RADIUS 13-1/4" WIDTH**

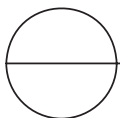

SCALE: N.T.S.

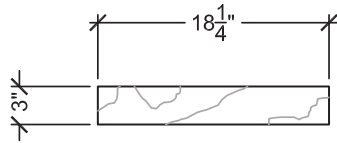

SIDE

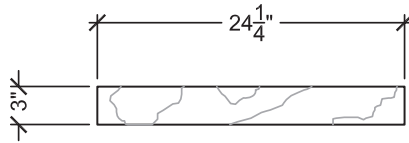

SIDE

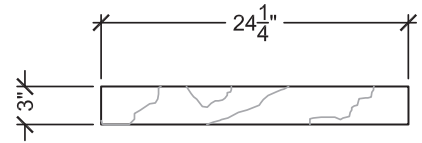

SIDE

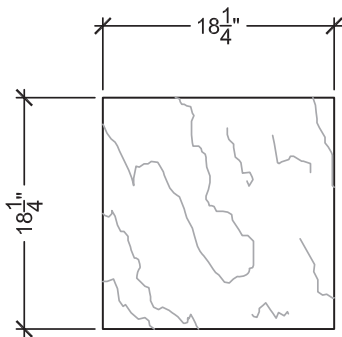

TOP

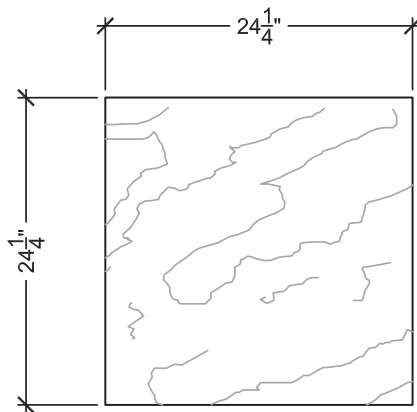

TOP

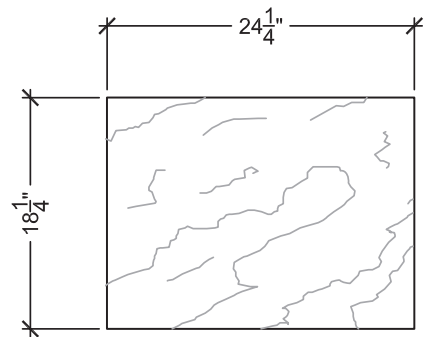

TOP

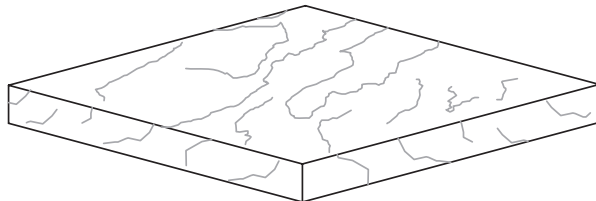

ISOMETRIC

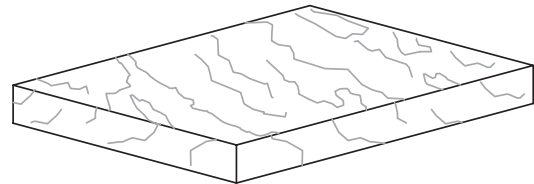

ISOMETRIC

NOTES:

1. PRECAST UNITS ARE INDIVIDUALLY HAND CAST. LENGTHS ARE APPROXIMATE. SOME VARIATIONS ARE EXPECTED.
2. INSTALLATION TO BE COMPLETED IN ACCORDANCE WITH GENERALLY ACCEPTED MASONRY PRACTICE.
3. SONORASTONE® FINISH ON TOP & SIDES.
4. PRECAST UNITS MAY BE CUT TO FIT FIELD CONDITIONS.

**SONORASTONE® FLAT  
PILASTER CAP - SIZES**

SCALE: N.T.S.

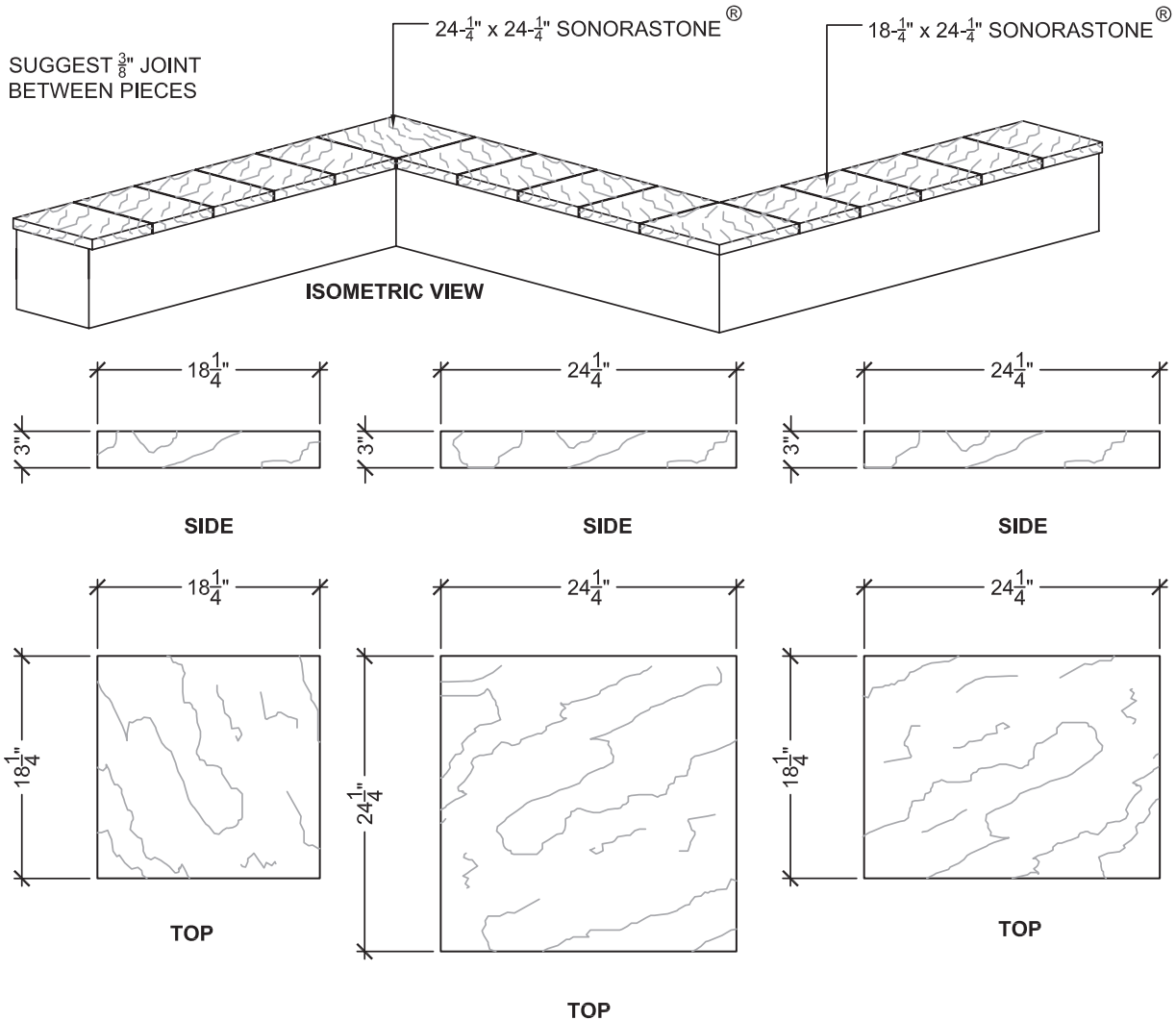

**NOTES:**

1. PRECAST UNITS ARE INDIVIDUALLY HAND CAST. LENGTHS ARE APPROXIMATE. SOME VARIATIONS ARE EXPECTED.
2. INSTALLATION TO BE COMPLETED IN ACCORDANCE WITH GENERALLY ACCEPTED MASONRY PRACTICE.
3. SONORASTONE® FINISH ON TOP & SIDES.
4. PRECAST UNITS MAY BE CUT TO FIT FIELD CONDITIONS.





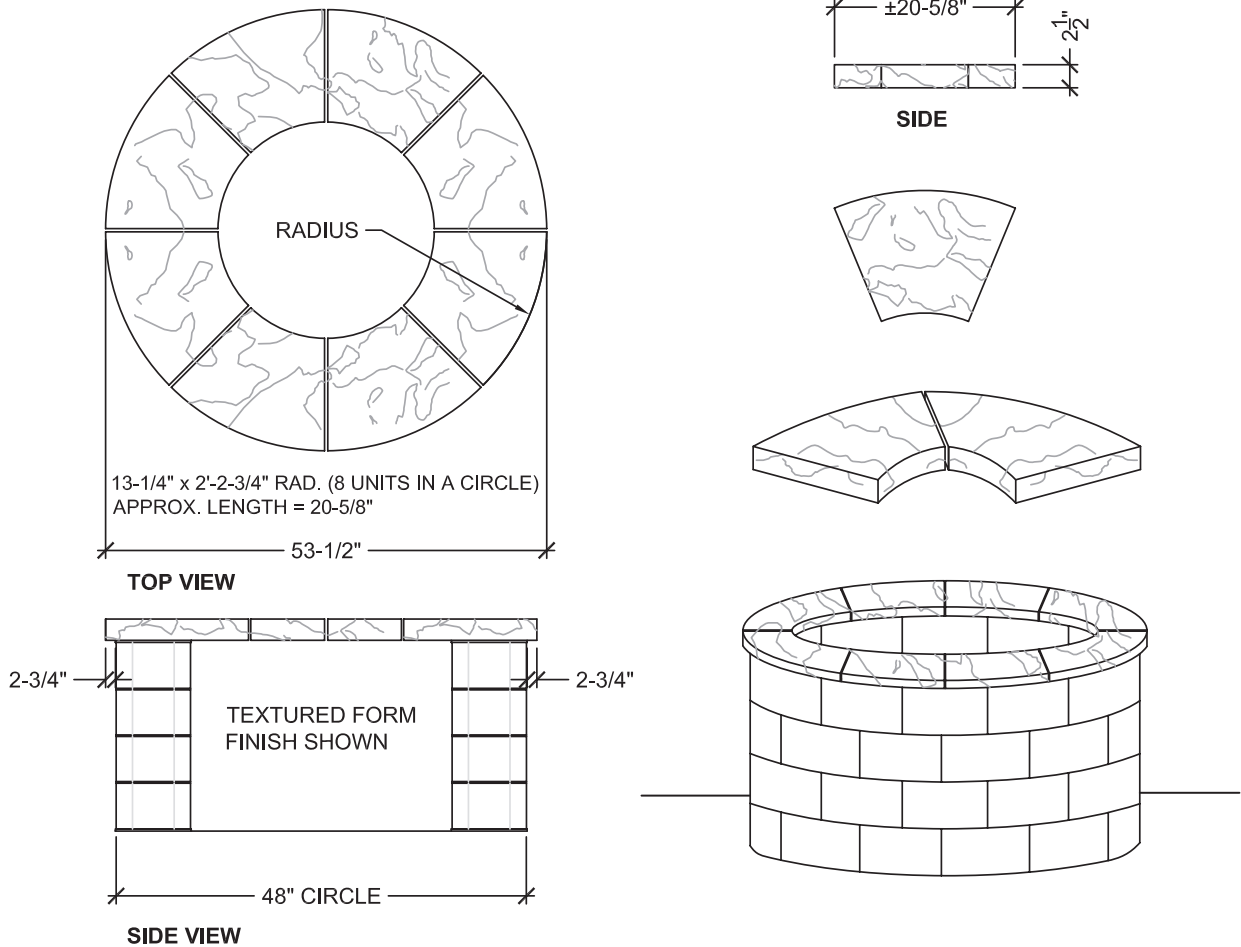

**NOTES:**

1. PRECAST UNITS ARE INDIVIDUALLY HAND CAST. LENGTHS ARE APPROXIMATE. SOME VARIATIONS ARE EXPECTED.
2. INSTALLATION TO BE COMPLETED IN ACCORDANCE WITH GENERALLY ACCEPTED MASONRY PRACTICES.
3. SONORASTONE® FINISH ON TOP AND SIDES.
4. PRECAST UNITS MAY BE CUT TO FIT FIELD CONDITIONS.
5. WE DO NOT RECOMMEND THE USE OF OUR CONCRETE PRODUCTS IN ENVIRONMENTS THAT WILL HEAT THE CONCRETE TO MORE THAN 200 DEGRESS. DIRECT EXPOSURE TO A FIRE'S FLAME FOR AN EXTENDED PERIOD OF TIME WILL DAMAGE THE CONCRETE. INSTALLATIONS SUBJECTING STEPSTONE'S PRECAST PIECES TO EXCESSIVE HEAT WILL VOID THE MANUFACTURER'S WARRANTY AND STEPSTONE, INC WILL NOT REPLACE ANY DAMAGED PRODUCT.



**SONORASTONE® FIRE PIT CAP**  
SCALE: N.T.S.

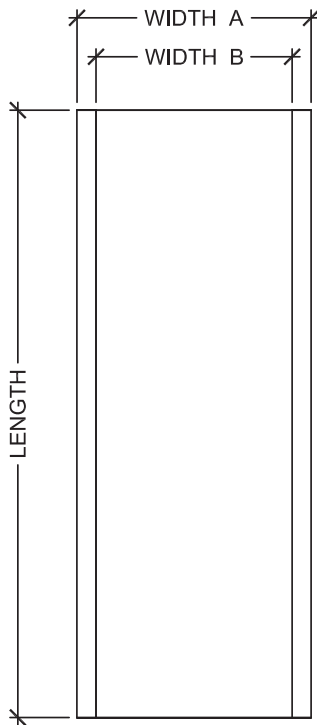
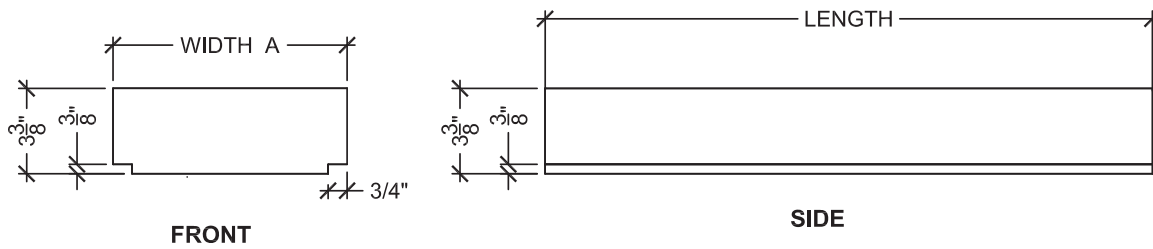

THICKNESS: 3-3/8"  
LENGTH: 24"

WIDTH A: 7-1/4"  
WIDTH B: 5-3/4"

WIDTH A: 9-1/4"  
WIDTH B: 7-3/4"

WIDTH A: 13-1/4"  
WIDTH B: 11-3/4"

WIDTH A: 20-1/4"  
WIDTH B: 18-3/4"

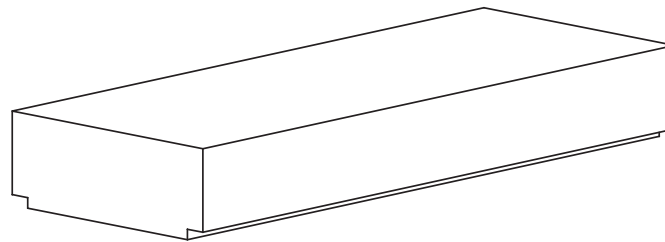

**BOTTOM**

**ISOMETRIC**

**NOTES:**

1. PRECAST UNITS ARE INDIVIDUALLY HAND CAST. LENGTHS ARE APPROXIMATE. SOME VARIATIONS ARE EXPECTED.
2. INSTALLATION TO BE COMPLETED IN ACCORDANCE WITH GENERALLY ACCEPTED MASONRY PRACTICE.
3. SMOOTH FINISH ON TOP AND SIDES. SANDBLAST FINISH AVAILABLE.
4. PRECAST UNITS MAY BE CUT TO FIT FIELD CONDITIONS.

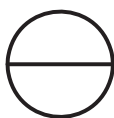

**Square Modular Wall Cap - Straight Pieces**

SCALE: N.T.S.

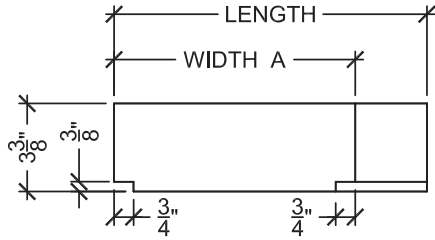

FRONT

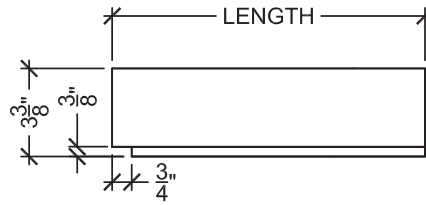

SIDE

THICKNESS: 3-3/8"

LENGTH: 10" SQ.  
WIDTH: 7-1/4"  
WIDTH: 5-3/4"

LENGTH: 12" SQ.  
WIDTH A: 9-1/4"  
WIDTH B: 7-3/4"

LENGTH: 16" SQ.  
WIDTH A: 13-1/4"  
WIDTH B: 11-3/4"

LENGTH: 23" SQ.  
WIDTH A: 20-1/4"  
WIDTH B: 18-3/4"

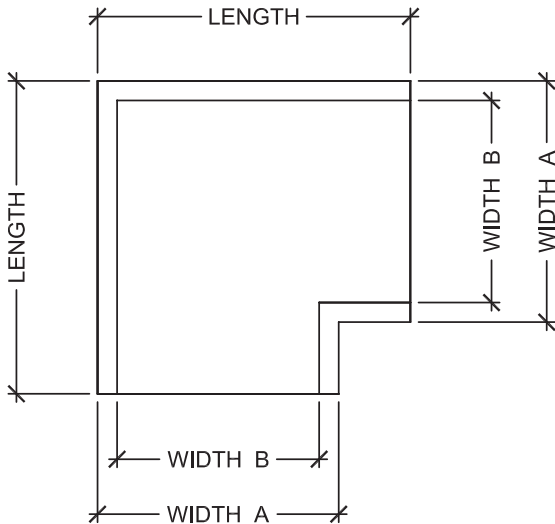

BOTTOM

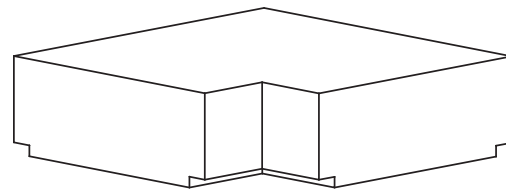

ISOMETRIC

NOTES:

1. PRECAST UNITS ARE INDIVIDUALLY HAND CAST. LENGTHS ARE APPROXIMATE. SOME VARIATIONS ARE EXPECTED.
2. INSTALLATION TO BE COMPLETED IN ACCORDANCE WITH GENERALLY ACCEPTED MASONRY PRACTICE.
3. SMOOTH FINISH ON TOP AND SIDES. SANDBLAST FINISH AVAILABLE.
4. PRECAST UNITS MAY BE CUT TO FIT FIELD CONDITIONS.

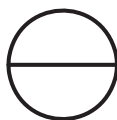

## Square Modular Wall Cap - Corner Pieces

SCALE: N.T.S.

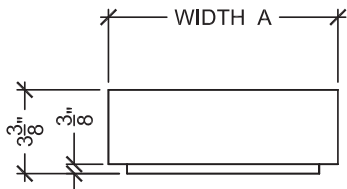

**FRONT**

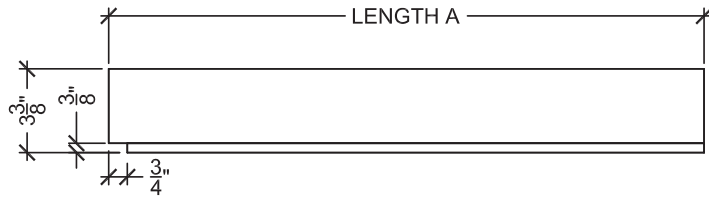

**SIDE**

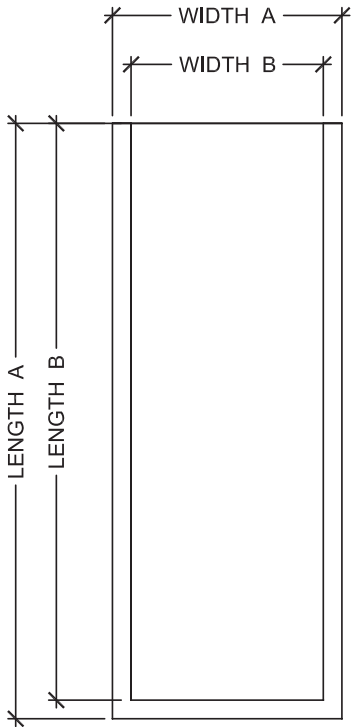

**BOTTOM**

THICKNESS: 3-3/8"  
LENGTH A: 24"  
LENGTH B: 23 1/4"

WIDTH A: 7-1/4"  
WIDTH B: 5-3/4"

WIDTH A: 9-1/4"  
WIDTH B: 7-3/4"

WIDTH A: 13-1/4"  
WIDTH B: 11-3/4"

WIDTH A: 20-1/4"  
WIDTH B: 18-3/4"

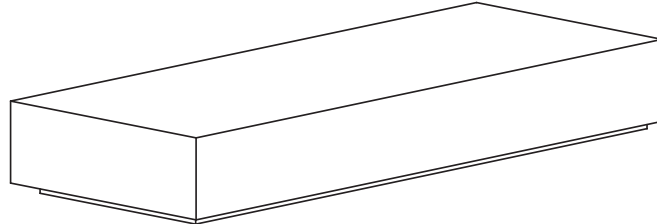

**ISOMETRIC**

**NOTES:**

1. PRECAST UNITS ARE INDIVIDUALLY HAND CAST. LENGTHS ARE APPROXIMATE. SOME VARIATIONS ARE EXPECTED.
2. INSTALLATION TO BE COMPLETED IN ACCORDANCE WITH GENERALLY ACCEPTED MASONRY PRACTICE.
3. SMOOTH FINISH ON TOP AND SIDES. SANDBLAST FINISH AVAILABLE.
4. PRECAST UNITS MAY BE CUT TO FIT FIELD CONDITIONS.

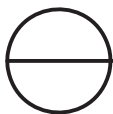

**Square Modular Wall Cap - End Pieces**

SCALE: N.T.S.

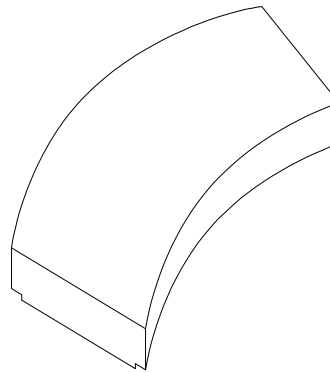
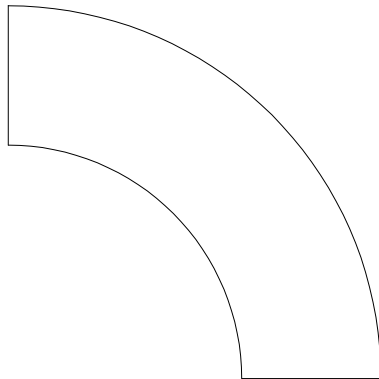
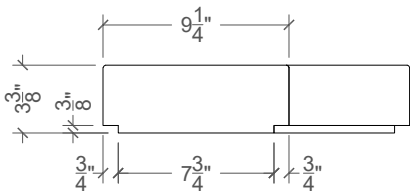

INSIDE RADIUS: 15  $\frac{1}{2}$ "    OUTSIDE RADIUS: 24  $\frac{3}{4}$ "    OUTSIDE LENGTH: 37  $\frac{5}{8}$ "    HEIGHT: 3  $\frac{3}{8}$ "

**NOTE:**

1. PRECAST UNITS ARE INDIVIDUALLY HAND CAST. LENGTHS ARE APPROXIMATE. SOME VARIATIONS ARE EXPECTED.
2. INSTALLATION TO BE COMPLETED IN ACCORDANCE WITH GENERALLY ACCEPTED MASONRY PRACTICE.
3. SMOOTH FINISH ON TOP. SANDBLAST FINISH AVAILABLE.
4. PRECAST UNITS MAY BE CUT TO FIT FIELD CONDITIONS.

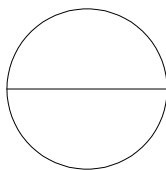

**SQUARE MODULAR WALL CAP, RADIUS**  
SCALE: N.T.S.

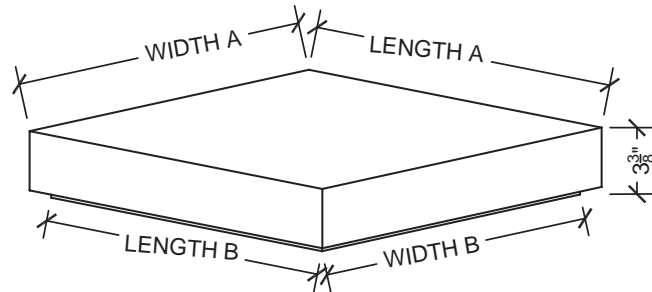
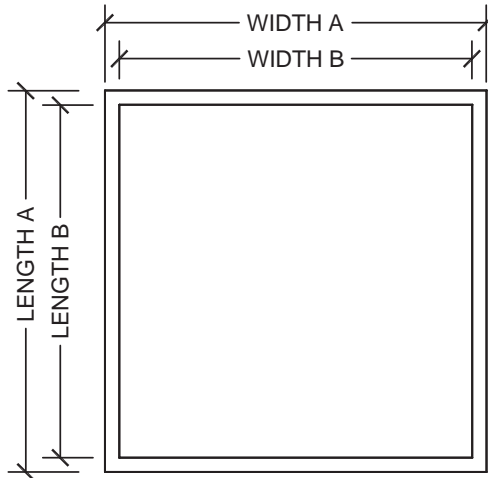
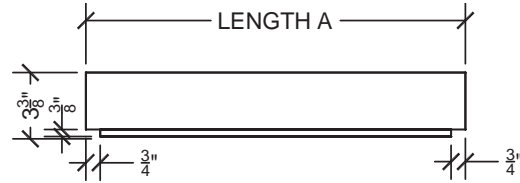
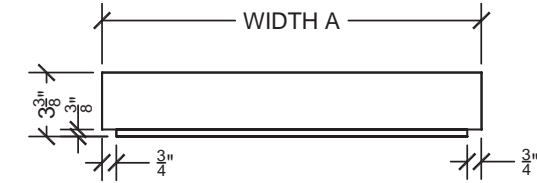

THICKNESS: 3<sup>3</sup>/<sub>8</sub>"

LENGTH A:	LENGTH B:	WIDTH A:	WIDTH B:
13 <sup>1</sup> / <sub>2</sub> "	12"	13 <sup>1</sup> / <sub>2</sub> "	12"
15 <sup>1</sup> / <sub>2</sub> "	14"	15 <sup>1</sup> / <sub>2</sub> "	14"
20"	18 <sup>1</sup> / <sub>2</sub> "	20"	18 <sup>1</sup> / <sub>2</sub> "
23 <sup>1</sup> / <sub>2</sub> "	22"	23 <sup>1</sup> / <sub>2</sub> "	22"
27 <sup>1</sup> / <sub>2</sub> "	26"	27 <sup>1</sup> / <sub>2</sub> "	26"

NOTES:

1. PRECAST UNITS ARE INDIVIDUALLY HAND CAST. LENGTHS ARE APPROXIMATE. SOME VARIATIONS ARE EXPECTED.
2. INSTALLATION TO BE COMPLETED IN ACCORDANCE WITH GENERALLY ACCEPTED MASONRY PRACTICE.
3. SMOOTH FINISH ON TOP AND NOSE. SANDBLAST FINISH AVAILABLE.
4. PRECAST UNITS MAY BE CUT TO FIT FIELD CONDITIONS.

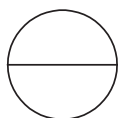

SQUARE MODULAR PILASTER CAP

SCALE: N.T.S.

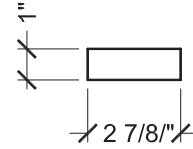
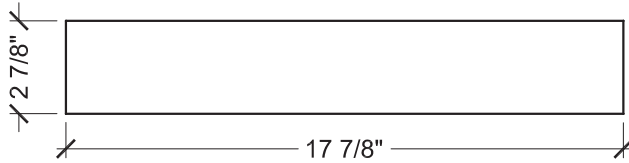

**SIDE VIEW**

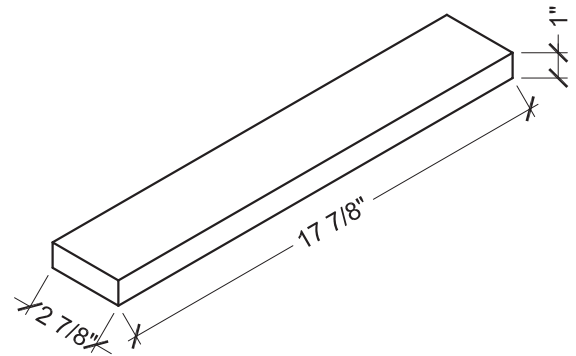
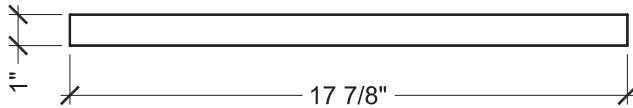

**ISOMETRIC VIEW**

**NOTES:**

1. VENEER SHOWN ABOVE SHALL BE 1" THICK AS MANUFACTURED BY STEPSTONE, INC. PAVERS SHALL HAVE A MINIMUM COMPRESSIVE STRENGTH OF 4,000 P.S.I.
2. THESE VENEER MUST BE MORTAR SET OR THIN SET.
3. SANDBLAST FINISH - LIGHT, MEDIUM OR HEAVY.
4. VENEER ARE AVAILABLE IN TWELVE (12) STANDARD COLORS. CUSTOM COLORS MAY BE AVAILABLE UPON REQUEST.
5. ALL DIMENSIONS ARE NOMINAL. SEE SPECIFICATIONS FOR TOLERANCES.

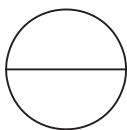

**VENEER, 3" X 18" X 1"**

SCALE: N.T.S.

**TOP VIEW**

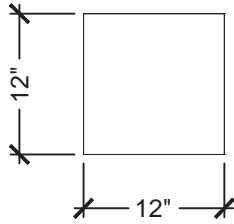

**SIDE VIEW**

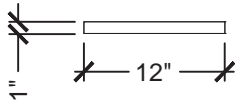

**SIDE VIEW**

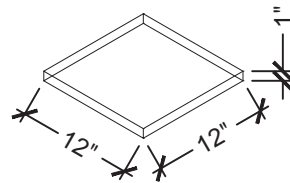
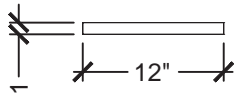

**ISOMETRIC VIEW**

**NOTES:**

1. CAL. ARC. VENEER SHOWN ABOVE SHALL BE 1" THICK AS MANUFACTURED BY STEPSTONE, INC. PAVERS SHALL HAVE A MINIMUM COMPRESSIVE STRENGTH OF 5,000 P.S.I.
2. THESE PAVERS CAN BE MORTAR SET.
3. SANDBLAST FINISH - LIGHT, MEDIUM OR HEAVY.
4. CAL. ARC. VENEER ARE AVAILABLE IN TWELVE (12) STANDARD COLORS. CUSTOM COLORS MAY BE AVAILABLE UPON REQUEST.
5. ALL DIMENSIONS ARE NOMINAL. ALL SIDES HAVE DRAFT. SEE SPECIFICATIONS FOR TOLERANCES.

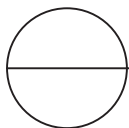

**CALIFORNIA ARCHITECTURAL VENEER, 12" X 12" X 1"**

SCALE: N.T.S.



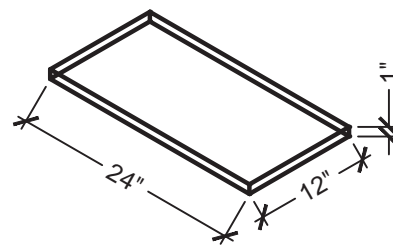
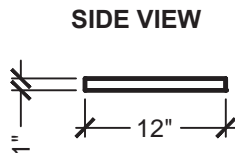
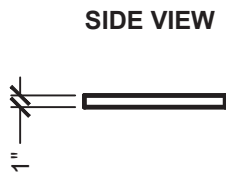
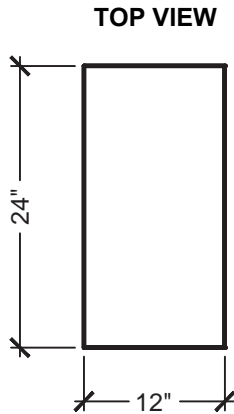

**ISOMETRIC VIEW**

**NOTES:**

1. CAL. ARC. VENEER SHOWN ABOVE SHALL BE 1" THICK AS MANUFACTURED BY STEPSTONE, INC. PAVERS SHALL HAVE A MINIMUM COMPRESSIVE STRENGTH OF 5,000 P.S.I.
2. THESE PAVERS CAN BE MORTAR SET.
3. SANDBLAST FINISH - LIGHT, MEDIUM OR HEAVY.
4. CAL. ARC. VENEER ARE AVAILABLE IN TWELVE (12) STANDARD COLORS. CUSTOM COLORS MAY BE AVAILABLE UPON REQUEST.
5. ALL DIMENSIONS ARE NOMINAL. ALL SIDES HAVE DRAFT. SEE SPECIFICATIONS FOR TOLERANCES.

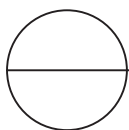

**CALIFORNIA ARCHITECTURAL VENEER, 12" X 24" X 1"**

SCALE: N.T.S.